

PDM-4210

**High definition plasma monitor
Moniteur plasma haute définition**



**USER'S MANUAL
MANUEL UTILISATEUR**







IMPORTANT SAFETY INSTRUCTIONS

SAFETY POINTS YOU SHOULD KNOW ABOUT YOUR Yamaha High Definition Plasma Monitor

Our reputation has been built on the quality, performance, and ease of service of Yamaha High Definition Plasma Monitor. Safety is also foremost in our minds in the design of these units. To help you operate these products properly, this section illustrates safety tips which will be of benefit to you. Please read it carefully and apply the knowledge you obtain from it to the proper operation of your Yamaha High Definition Plasma Monitor.

Follow all warnings and instructions marked on this monitor.

 CAUTION RISK OF ELECTRIC SHOCK DO NOT OPEN		 <p>The lightning flash with arrowhead symbol, within an equilateral triangle, is intended to alert the user to the presence of uninsulated "dangerous voltage" within the product's enclosure that may be of a sufficient magnitude to constitute a risk of electric shock to persons.</p>
CAUTION: TO REDUCE THE RISK OF ELECTRIC SHOCK, DO NOT REMOVE COVER (OR BACK). NO USER SERVICEABLE PARTS INSIDE. REFER SERVICING TO QUALIFIED SERVICE PERSONNEL.		The exclamation point within an equilateral triangle, is intended to alert the user to the presence of important operating and maintenance (servicing) instructions in the literature accompanying the appliance.

WARNING:

- TO PREVENT FIRE OR SHOCK HAZARD, DO NOT EXPOSE THIS MONITOR TO RAIN OR MOISTURE.
- THE MONITOR SHOULD NOT BE EXPOSED TO DRIPPING OR SPLASHING AND OBJECTS FILLED WITH LIQUIDS, SUCH AS VASES, SHOULD NOT BE PLACED ON THE MONITOR.

NOTE:

- There are no user serviceable parts inside the monitor.
- Model and serial numbers are indicated on back side of the monitor.

CAUTION: Adjust only those controls that are covered in the instructions, as improper changes or modifications not expressly approved by YAMAHA could void the user's authority to operate the monitor.

POWER SOURCE

THIS MONITOR IS DESIGNED TO OPERATE ON 120 VOLTS 60Hz, ALTERNATING CURRENT. INSERT THE POWER CORD INTO A 120 VOLT 60Hz OUTLET.

TO PREVENT ELECTRIC SHOCK, DO NOT USE THE MONITOR'S (POLARIZED) PLUG WITH AN EXTENSION CORD, RECEPTACLE, OR OTHER OUTLET UNLESS THE BLADES AND GROUND TERMINAL CAN BE FULLY INSERTED TO PREVENT BLADE EXPOSURE.

NEVER CONNECT THE MONITOR TO DIRECT CURRENT OR ANYTHING OTHER THAN THE SPECIFIED VOLTAGE.

 **CAUTION:** Never remove the back cover of the monitor as this can expose you to very high voltages and other hazards. If the monitor does not operate properly, unplug the monitor and call your authorized dealer or service center.

For Canadian customers:

To prevent electric shock, match wide blade of plug to wide slot and fully insert.
This Class B digital apparatus complies with Canadian ICES-003.

**READ ALL INSTRUCTIONS CAREFULLY.
KEEP THIS USER'S MANUAL FOR FUTURE REFERENCE.**

For future reference, record the serial number of your monitor.

SERIAL NO.
The serial number is located on the rear of the monitor.



IMPORTANT SAFETY INSTRUCTIONS

Read before operating equipment

Follow all warnings and instructions marked on this monitor.

1. Read these instructions.
2. Keep these instructions.
3. Heed all warnings.
4. Follow all instructions.
5. Do not use this apparatus near water.
6. Clean only with a dry cloth.
7. Do not block any ventilation openings. Install in accordance with the manufacturer's instructions.
8. Do not install near any heat sources such as radiators, heat registers, stoves, or other apparatus (including amplifiers) that produce heat.
9. Do not defeat the safety purpose of the polarized or grounding-type plug. A polarized plug has two blades with one wider than the other. A grounding type plug has two blades and a third grounding prong. The wide blade or the third prong are provided for your safety. If the provided plug does not fit into your outlet, consult an electrician for replacement of the obsolete outlet.
10. Protect the power cord from being walked on or pinched particularly at plugs, convenience receptacles, and the point where they exit from the apparatus.
11. Only use the attachments/accessories specified by the manufacturer.
12.  Use only with the cart, stand, tripod, bracket, or table specified by the manufacturer, or sold with the apparatus. When a cart is used, use caution when moving the cart/apparatus combination to avoid injury from tip-over.
13. Unplug this apparatus during lightning storms or when unused for long periods of time.
14. Refer all servicing to qualified service personnel. Servicing is required when the apparatus has been damaged in any way, such as power-supply cord or plug is damaged, liquid has been spilled or objects have fallen into apparatus, the apparatus has been exposed to rain or moisture, does not

15. Monitors are designed to comply with the recommended safety standards for tilt and stability. Do not apply excessive pulling force to the front, or top, of the cabinet which could cause the product to overturn resulting in product damage and/or personal injury.
16. Follow instructions for wall, shelf or ceiling mounting as recommended by the manufacturer.
17. An outdoor antenna should not be located in the vicinity of overhead power lines or other electrical circuits.
18. If an outside antenna is connected to the receiver be sure the antenna system is grounded so as to provide some protection against voltage surges and built up static charges. Section 810 of the National Electric Code, ANSI/NFPA No. 70-1984, provides information with respect to proper grounding for the mast and supporting structure, grounding of the lead-in wire to an antenna discharge unit, size of grounding connectors, location of antenna-discharge unit, connection to grounding electrodes and requirements for the grounding electrode.

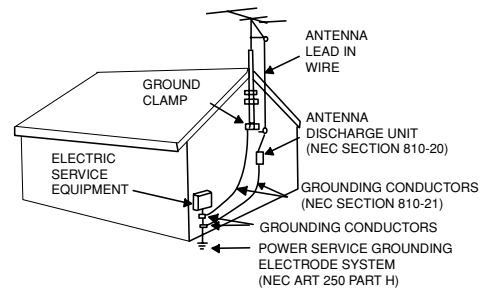

NEC NATIONAL ELECTRICAL CODE

Note to the CATV system installer: This reminder is provided to call the CATV system installer's attention to Article 820-40 of the NEC that provides guidelines for proper grounding and, in particular, specifies that the cable ground shall be connected to the grounding system of the building, as close to the point of cable entry as practical.

Do not place any objects on the top of the monitor which may fall or cause a child to climb to retrieve the objects.

Disposal of this product may require specific instructions pertaining to your resident state. For disposal or recycling information, please contact your local authorities or the Electronic Industries Alliance: www.eiae.org.

PREVENTION OF IMAGE RETENTION

Continuous on-screen displays such as video games, stock market quotations, computer generated graphics, and other fixed (non-moving) patterns can cause permanent damage to the monitor.

PUBLIC VIEWING OF COPYRIGHTED MATERIAL

Public viewing of programs broadcast by TV stations and cable companies, as well as programs from other sources, may require prior authorization from the broadcaster or owner of the video program material.

• **FCC (Federal Communications Commission) STATEMENT WARNING**

COMPLIANCE INFORMATION STATEMENT

(DECLARATION OF CONFORMITY PROCEDURE)

Responsible Party: Yamaha Electronics Corporation
Address: 6660 Orangethorpe Avenue
Buena Park, CA90620
Telephone: 714-522-9105
Fax: 714-670-0108
Type of Equipment: High Definition Plasma Monitor
Model Name: PDM-4210

This device complies with Part 15 of the FCC Rules.

Operation is subject to the following conditions:

- 1) this device may not cause harmful interference, and
 - 2) this device must accept any interference received including interference that may cause undesired operation.
- See the user manual instructions if interference to radio reception is suspected.

FCC INFORMATION (for US customers only)

1. IMPORTANT NOTICE: DO NOT MODIFY THIS UNIT!

This product, when installed as indicated in the instructions contained in this manual, meets FCC requirements.

Modifications not expressly approved by Yamaha may void your authority, granted by the FCC, to use the product.

2. IMPORTANT: When connecting this product to accessories and/or another product use only high quality shielded cables. Cable/s supplied with this product **MUST** be used. Follow all installation instructions. Failure to follow instructions could void your FCC authorization to use this product in the USA.

3. NOTE: This product has been tested and found to comply with the requirements listed in FCC Regulations, Part 15 for Class "B" digital devices. Compliance with these requirements provides a reasonable level of assurance that your use of this product in a residential environment will not result in harmful interference with other electronic devices.

This equipment generates/uses radio frequencies and, if not installed and used according to the instructions found in the users manual, may cause interference harmful to the operation of other electronic devices.

Compliance with FCC regulations does not guarantee that interference will not occur in all installations. If this product is found to be the source of interference, which can be determined by turning the unit "OFF" and "ON", please try to eliminate the problem by using one of the following measures:

Relocate either this product or the device that is being affected by the interference.

Utilize power outlets that are on different branch (circuit breaker or fuse) circuits or install AC line filter/s.

In the case of radio or TV interference, relocate/reorient the antenna. If the antenna lead-in is 300 ohm ribbon lead, change the lead-in to coaxial type cable.

If these corrective measures do not produce satisfactory results, please contact the local retailer authorized to distribute this type of product. If you can not locate the appropriate retailer, please contact Yamaha Electronics Corp., U.S.A. 6660 Orangethorpe Ave, Buena Park, CA 90620.

The above statements apply **ONLY** to those products distributed by Yamaha Corporation of America or its subsidiaries.

USER'S MANUAL

Thank you very much for purchasing the Yamaha High Definition Plasma Monitor.

Before using your monitor, please carefully read this manual so you will know how to operate the monitor properly. Keep this manual in a safe place. You will find it useful in the future.

Notes on Installation Work:

This product is marketed assuming that it is installed by qualified personnel with enough skill and competence. Always have an installation specialist or your dealer install and set up the product. YAMAHA cannot assume liabilities for damage caused by mistake in installation or mounting, misuse, modification or a natural disaster.

Note for Dealers:

After installation, be sure to deliver this manual to the customer and explain to the customer how to handle the product.

Notes about This Manual

- The information in this manual is subject to change without notice.
- While meticulous care has been taken in the preparation of this manual, you are requested to notify your dealer or us should you have any comments, views or questions about our product.
- Fully understand the prerequisites to using the product, such as hardware and software specifications and constraints, in using the product. We are not held liable for damages caused by improper handling of the product.
- Reproduction of this manual in whole or in part without our prior written permission is prohibited.
- The product names mentioned in this manual may be trademarks or registered trademarks of their respective owners.

FEATURES

Large-screen, high-definition plasma display panel

The 42-inch color plasma display panel, with a resolution of 1024 (H) x 1024(V) pixels, creates a high-definition, large-screen (aspect ratio : 16:9) and low-profile flat display. Free from electromagnetic interferences from geomagnetic sources and ambient power lines, the panel produces high-quality display images free from color misconvergence and display distortion.

High Performance Digital Processor

A wide range of personal computer signals can be handled, from 640 x 400, 640 x 480 VGA to 1600 x 1200 UXGA.

Easy-to-use remote control and on screen display system

The remote control included eases the work of setting display controls. Further, the on-screen display system, displays the status of signal reception and display control settings in an easy-to-view fashion.

TruBass[®] by SRS[®]

TruBass, SRS and (O) symbol are trademarks of SRS Labs, Inc. TruBass technology is incorporated under license from SRS Labs, Inc.

About the Optional Video Unit

The following functions can be obtained by connecting the optional video unit.

- (1) A Composite/S video terminal and two component terminals have been added. A composite video output terminal is also provided as a monitoring output.
- (2) A wide range of devices other than personal computers can also be connected.
- (3) It is possible to switch the component terminal to RGB input from the Menu screen.
- (4) A SCART terminal is also provided for the signal of the European standard. It operates as composite/S/RGB input terminal, or video output terminal.

Options

Ask your local retail dealer for further details on the following optional attachments.

- Pedestal
PDS-242
- Wall Mounting Unit
PWK-242
- Video Unit
PTB-4210

An expansion unit for viewing video with this device.

- This User's Manual was printed before final product development. After printing, some product specifications may change due to operational upgrades and other reasons. In this case, the specifications of the product itself will take precedence over the specifications in this manual.
- TRADEMARK ACKNOWLEDGEMENT
VGA and XGA are registered trademarks of International Business Machines Corporation.
APPLE and Macintosh are registered trademarks of Apple Computer, Inc.
All brand or product names are trademarks or registered trademarks of their respective holders.

CONTENTS

FEATURES	4
CAUTION: READ THIS BEFORE OPERATING YOUR UNIT.	5
PRECAUTIONS	8
COMPONENT NAMES	9
Main Unit	9
Remote control	10
Loading Batteries	10
Handling the Remote Control	10
INSTALLATION INSTRUCTIONS	11
Installation	11
Anti-tumble measures	11
Connecting to a PC	12
Power Cord Connection	13
OPERATING INSTRUCTIONS	14
Turning Power On and Off	14
Input Switching	15
Volume Adjustment	15
Audio Mute	15
Size Switching	16
Input Signal Screen Display	16
Automatic Adjustment of Screen Position and the Clock	17
Independent Operation of Multiple Monitors	17
Using the Menu Screen	17
PICTURE MENU.....	18
AUDIO MENU.....	19
TIMER MENU	19
FUNCTION MENU	20
SETUP MENU.....	21
LANGUAGE MENU	22
OTHER FEATURES	22
Automatic Store	22
Signal Check	23
Power Save Mode	23
IMAGE RETENTION OF PLASMA DISPLAY PANEL	24
NOTES	24
TROUBLESHOOTING	25
Symptoms That Appear to be Failures	25
Actions to Correct Abnormal Displays	27
PRODUCT SPECIFICATIONS	28
Signal Input.....	28
Recommended Signal List	29
SUPPLEMENT	31
Optional Video Unit Function	32

NOTE:

Please refer to the "SUPPLEMENT" for more information if the model you are using comes with a video unit.

CAUTION: READ THIS BEFORE OPERATING YOUR UNIT.

This Plasma monitor has been designed and manufactured to meet international safety standards, but like any electrical equipment, care must be taken if you are to obtain the best results and safety is to be assured.

Before using this product, please read and understand the Safety Instructions thoroughly to ensure correct usage, and follow all the instructions.

Never use the monitor if a problem occurs.

Abnormal operations such as smoke, strange odor, no image, no sound, excessive sound, damaged casing, elements, cables, penetration of liquids or foreign matter, etc. can cause a fire or electrical shock.

In such case, immediately turn off the power switch and then disconnect the power plug from the power outlet. After making sure that the smoke or odor has stopped, contact your dealer. Never attempt to make repairs yourself because this could be dangerous.

Do not insert liquids or foreign objects.

Penetration of liquids or foreign objects could result in fire or electrical shock. Use special caution in households where children are present.

If liquids or foreign objects should enter the projector, immediately turn off the power switch, disconnect the power plug from the power outlet and contact your dealer.

- Do not place the monitor in a bathroom.
- Do not expose the monitor to rain or moisture.
- Do not place flower vases, pots, cups, cosmetics, liquids such as water, etc on or around the monitor.
- Do not place metals, combustibles, etc on or around the monitor.

Never disassemble or modify the monitor.

The monitor contains high voltage components. Modification could result in fire or electrical shock.

- Never remove any fixed cover.

Do not give the monitor any shock or impact.

If the monitor should be shocked and/or broken, it could result in an injury, and continued use could result in fire or electrical shock.

If the glass panel is broken or damaged, immediately turn off the power switch, disconnect the power plug from the power outlet and contact your dealer.

Do not place the monitor on an unstable surface.

If the monitor should be dropped and/or broken, it could result in an injury, and continued use could result in fire or electrical shock.

- Do not place the monitor on an unstable, slanted or vibrating surface such as a wobbly or inclined stand.

Do not obstruct the ventilation of the monitor.

If the ventilation is obstructed during the operation of the monitor or just after switching off the power, it could result in damage and shorten the lifespan of your monitor due to overheating. Make sure there is ample ventilation.

- Keep a space of 100mm (10cm) or more between the sides, rear and top of the monitor and other objects such as walls.
- Do not place anything around ventilation openings of the monitor.
- Never block ventilation openings.
- Do not put the plasma display panel side up.
- Do not cover the monitor with a tablecloth, etc.
- Do not place the monitor on a carpet or bedding, or near a curtain.

Use only the correct power outlet.

Incorrect power supply could result in fire or electrical shock. Use only the correct power outlet depending on the indication on the monitor and the safety standard.

- The enclosed power cord must be used depending on the power outlet to be used.

Be cautious of the power cord connection.

Incorrect connection of the power cord could result in fire or electrical shock.

- Do not touch the power cord with a wet hand.
- Check that the connecting portion of the power cord is clean (with no dust), before using. Use a soft and dry cloth to clean the power plug.
- Insert the power plug into a power outlet firmly. Avoid using a loose, unsound outlet or contact failure.
- Do not cut off the fitted power plug, the removal of which could lead to impaired performance. If you wish to extend the lead, obtain an appropriate extension lead or consult your dealer.
- Should you require replacing the fuse in the molded plug with a new fuse, then please replace with new one of the same value, type and approval as the original. Ensure the fuse cover is returned to its original position.

Be sure to keep safety ground connection.

Connect the ground terminal of AC inlet of this monitor with the ground terminal provided at the power outlet using the enclosed power cord. If the provided plug does not fit your outlet, consult an electrician for replacement of the obsolete outlet.

CAUTION: READ THIS BEFORE OPERATING YOUR UNIT.(continued)

Be careful in handling the power cord and external connection cables.

If you keep using a damaged the power cord or cables, it can cause a fire or electrical shock. Do not apply too much heat, pressure or tension to the power cord and cables.

If the power cord or cables are damaged (exposed or broken core wires, etc.), contact your dealer.

- Do not place the monitor or heavy objects on the power cord and cables. Also, do not place a spread, cover, etc, over them because this could result in the inadvertent placing of heavy objects on the concealed power cord or cables.
- Do not pull the power cord and cables. When connecting and disconnecting the power cord or cables, do it with your hand holding the plug or connector.
- Do not place the cord near the heater.
- Do not touch the power plug just after disconnecting it from the power outlet to prevent electric shock.
- Do not touch the power plug when lightning is close to you.
- Avoid coiling the power cord and bending it sharply.
- Protect the power cord from being walked on, pinched particularly at plugs, conveniences receptacles, and the point where they exit from the apparatus.
- Do not modify the power cord.

Be careful in handling the battery of the remote control.

Incorrect handling of the battery could result in fire or personal injury. The battery may explode if not handled properly.

- Keep the battery away from children and pets. If swallowed consult a physician immediately for emergency treatment.
- Do not allow the battery to be exposed to fire or water.
- Avoid fire or high-temperature environment.
- Do not hold the battery with metallic tweezers.
- Keep the battery in a dark, cool and dry place.
- Do not short circuit the battery.
- Do not recharge, disassemble or solder the battery.
- Do not physically impact the battery.
- Use only the battery specified in the manual of this monitor.
- Make sure the plus and minus terminals are correctly aligned when loading the battery.
- If you observe a leakage of the battery, wipe out the liquid and then replace the battery. If the liquid adheres your body or clothes, rinse well with water.
- Obey the local laws on disposing the battery.

Be careful in moving the monitor.

Neglect could result in an injury or damage.

- Do not move the monitor during use. Before moving, disconnect the power plug and all external connections.
- You are advised to move the monitor with two persons.
- Avoid any impact or shock to the monitor; particularly take care of glass screen.

Do not put anything on top of the monitor.

Placing anything on the monitor could result in loss of balance or falling, and cause an injury or damage. Use special caution in households where children are present.

Avoid a humid or dusty place.

Placing the monitor in a smoke, a highly humid, dusty place, oily soot or corrosive gas could result in fire or electrical shock.

- Do not place near the kitchen, a humidifier or other place where there is oil, smoke or humidity.

Avoid a high temperature environment.

The heat could have adverse influence on the monitor and other parts, and could result in transformation, melting or fire.

- Do not place the monitor, the remote control and other parts in direct sunlight or near a hot object such as heater, etc.
- Do not put the monitor in a place where the temperature is widely changing.

Remove the power cord for complete separation.

- For safety purposes, disconnect the power cord if the monitor is not to be used for prolonged periods of time.
- Before cleaning, turn off and unplug the monitor. Neglect could result in fire or electrical shock.

How to view the monitor

If you use the monitor in too dark a room, your eyes may become tired.

Please use it in a reasonably bright room.

Avoid direct rays of the sun to the screen in order to prevent eye fatigue.

Your eyes will get fatigued after viewing the monitor for long period of time.

Relax your eyes by viewing away from the monitor from time to time.

Please watch the monitor in downward direction.

Note on image retention

The plasma monitor illuminates phosphor to display images. The phosphor has a finite illumination life. After extended periods of illumination, the brightness of the phosphor will be degraded to such extent that stationary images would burn-in that part of the screen as grayed-out images.

Tips to prevent such image retention are:

- Do not display images having sharp brightness differences or high-contrast images, such as monochrome characters and graphic patterns, for long.
- Do not leave stationary images appearing for long, but try to refresh them at appropriate intervals of time, or try to move them using screen saver function.
- Turn down the contrast and brightness controls.

How to clean the plasma display panel of the monitor

Before cleaning the monitor, turn off the monitor and disconnect the power plug from the power outlet.

To prevent scratching or damaging the plasma display panel face, do not knock or rub the surface with sharp or hard objects. Clean the screen with a soft cloth moistened with warm water and dry with a soft cloth. If it is not enough, then use a cloth with mild detergent. Do not use harsh or abrasive cleaners.

How to clean the cabinet of the monitor

Use a soft cloth to clean the cabinet and control panel of the monitor. When the plasma monitor is excessively soiled dilute a neutral detergent in water, wet and wring out the soft cloth and afterward wipe with a dry soft cloth.

Never use acid/alkaline detergent, alcoholic detergent, abrasive cleaner, powder soap, OA cleaner, car wax, glass cleaner, etc. especially because they would cause discoloration, scratches or cracks.

Prevention of an obstacle to Radio receivers

This monitor has been designed pursuant to the international EMI standards. This is to prevent a problem to Radio receivers.

- Keep the monitor away from Radio.
- Adjust Radio antennas in order for the monitor not to receive interference.
- The antenna cable of Radio should be kept away from the monitor.
- Use a coaxial cable for antenna.

You can check if this monitor influences Radio receivers by turning off all other equipment other than the monitor.

If you find a problem receiving Radio when using the monitor, check the instructions mentioned above.

Precautions for the cable connection

- Do ensure that all connections, (including the power plug, extension leads and interconnections between the pieces of equipment), are properly made and in accordance with the manufacturers instructions. Switch off and withdraw the power plug before making or changing connections.
- Confirm the connector is fixed tightly when the signal cable is connected.
Also confirm the screws on the connector are tightened.
- Plug the power cord of the monitor into a different socket from that for other equipment, such as Radio etc..
- Use a plug with ground terminal and make sure that it connects to the ground.

Precaution during transportation

Please pay attention when you transport this monitor because it is heavy.

Furthermore, use the original carton box and its packaging materials when the monitor is transported.

Failure to transport the monitor in any carton except the original carton may result in damage to the monitor.

Save the original carton box and all packing material.

Do not physically impact the remote control.

A physical impact could cause damage or malfunction of the remote control.

- Take care not to drop the remote control.
- Do not place heavy objects on the remote control.

Avoid strong rays.

Any strong rays (such as direct sun rays or room lighting) onto the remote control sensors could invalidate the remote control.

Avoid radio interference.

Any interfering radiation could cause distorted images or noises.

- Avoid radio generator such as a mobile telephone, transceiver, etc. around the monitor.

Set the sound volume at a suitable level.

It is better to keep the volume level low and close the windows at night to protect the neighborhood environment.

CAUTION: READ THIS BEFORE OPERATING YOUR UNIT.(continued)

Precautions for the installation

- Do not use makeshift pedestals and NEVER fix legs with wood screws - to ensure complete safety, always fit the manufacturers approved pedestal or legs with the fixings provided according to the instructions.
- Use only with the cart, pedestal, tripod, bracket, or table specified by the manufacturer, or sold with the apparatus. When a cart is used, use caution when moving the cart/apparatus combination to avoid injury from tip-over.
- This product is designed to comply with the recommended safety standards for tilt and stability. Do not apply excessive pulling force to the front, or top, of the cabinet that could cause the product to overturn resulting in product damage and/or personal injury.
- Follow instructions for wall, shelf or ceiling mounting as recommended by the manufacturer.
- Only use the attachments/accessories specified by the manufacturer.
- Consult your dealer if you are in any doubt about installation, operation or safety of your equipment.

Other precautions

- Do not leave equipment switched on when it is unattended unless it is specifically stated that it is designed for unattended operation or has a stand-by mode. Switch off using the switch on the equipment and show your family how to do this. Make special arrangements for infirm or handicapped people.
- Disposal of this product may require specific instructions pertaining to your resident region.
- Never guess or take any chances with electrical equipment of any kind - it is better to be safe than sorry!

PRECAUTIONS

- Please read this User's Manual thoroughly, especially the "IMPORTANT SAFETY INSTRUCTIONS" and the "CAUTION:READ THIS BEFORE OPERATING YOUR UNIT." and the "PRECAUTIONS" sections. Mis-use may cause damage to your plasma monitor, which could shorten its lifespan, or cause injury to yourself. Should you encounter any difficulty in the set-up or operation of your monitor, firstly refer to the Troubleshooting guide at the rear of this manual.
In the unlikely event of a problem occurring with your plasma monitor, switch off at the mains sockets, pull out the plugs, and contact your dealer immediately.
- Under no circumstances remove the rear cover of your plasma monitor.
Never guess or take any chances with electrical equipment of any kind - it is better to be safe than sorry!
- It is prohibited for the end user of this product to copy, reverse engineer or reverse compile the software included therein, save to the extent permitted by law.
- After the plasma monitor has been turned on for any length of time, you will notice that the screen becomes warm. Please note that this is normal.
Sometimes the screen might have some tiny bright or dark spots. Please note that this is normal.
- To prevent scratches or damages to the plasma display panel, do not knock or rub the surface with sharp or hard objects.

COMPONENT NAMES

Main Unit

Front

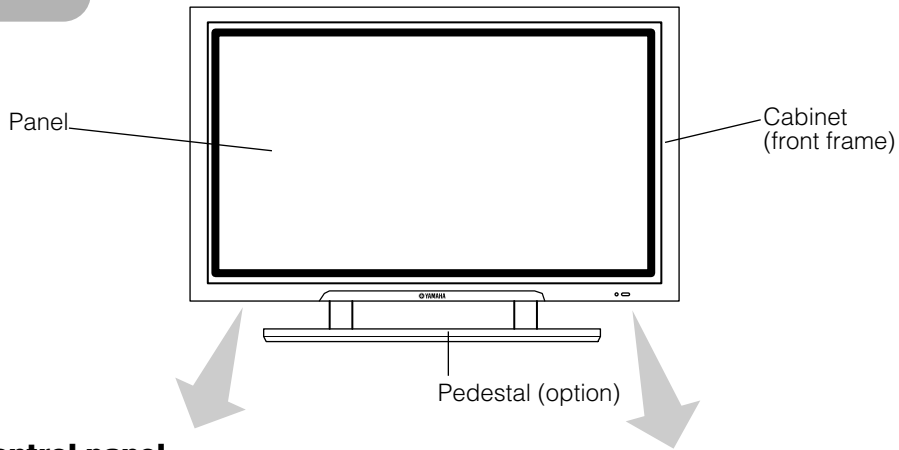

Control panel

- Adjustment buttons are located on the **bottom**.
- The back cover is provided with indications to distinguish the adjustment buttons.

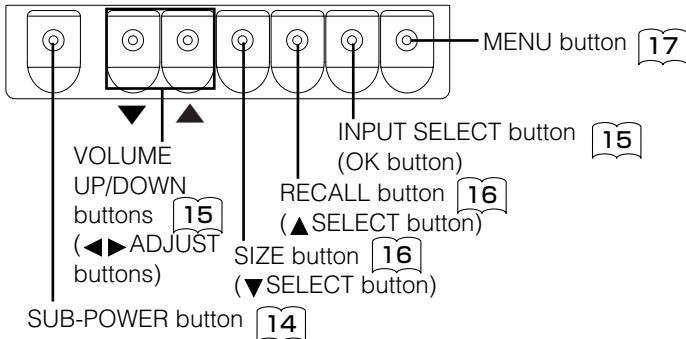
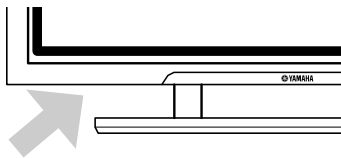

- () indicates the function while the MENU is displayed on the screen.

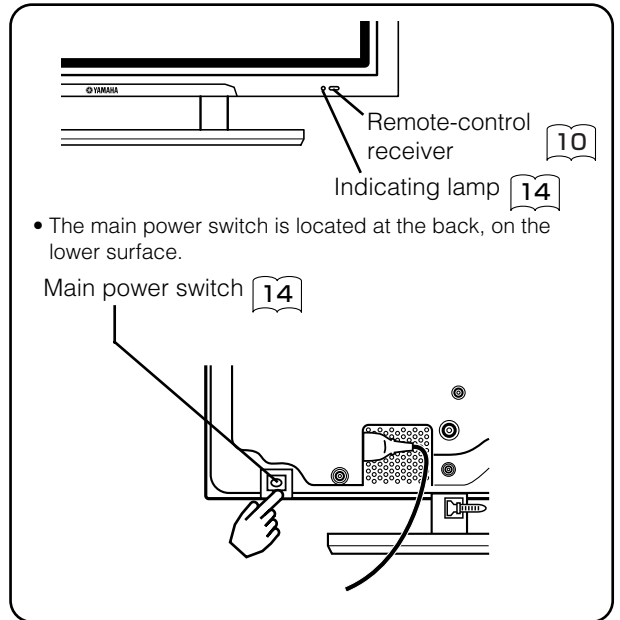

Caution when moving the main unit

- As this product is heavy, whenever it is moved, two people are required to transport it safely.
- Whenever the unit is moved it should be lifted forwards using the two handgrips at the back, and the unit should then be held at the base on both sides for stability.

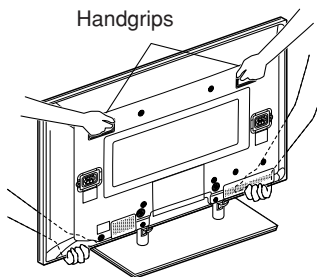

Rear

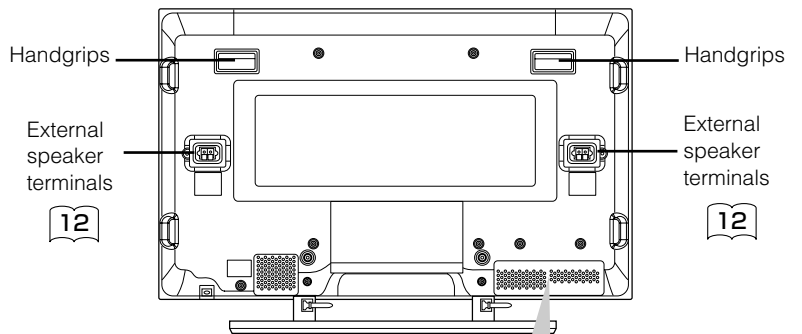

External device connection terminals

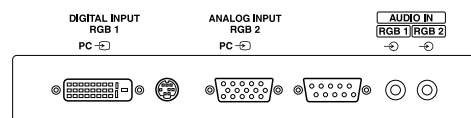

RGB input terminals 12

COMPONENT NAMES (continued)

Remote control

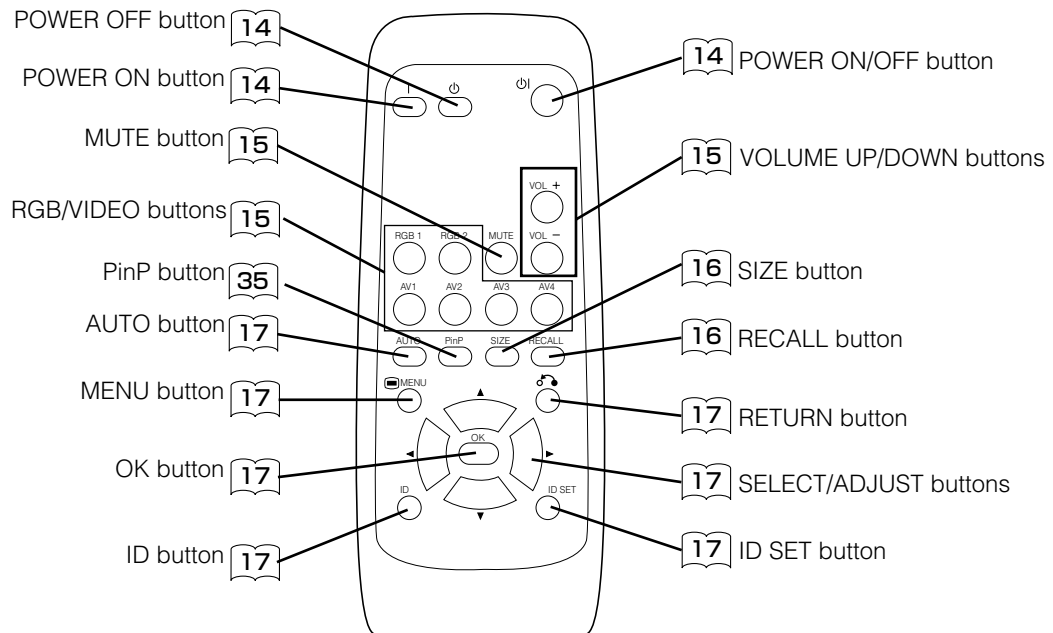

Loading Batteries

1. Open the battery cover.

- Slide back and remove the battery cover in the direction of the arrow.

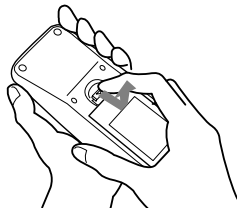

2. Load the batteries.

- Load the two Size AA batteries included, matching polarity markings on the batteries to those on the case.

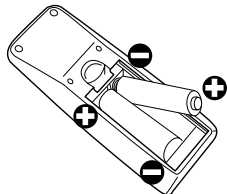

3. Close the battery cover.

- Replace the battery cover in the direction of the arrow and snap it back into place.

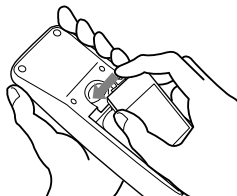

Handling the Remote Control

Use the remote control within 5 m from the front of the unit, within a 30 degree arc either side of the remote control sensor.

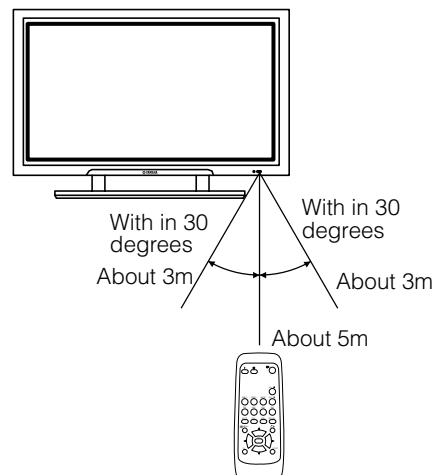

CAUTION

- Do not use new and old batteries together. The batteries could explode or leak, resulting in fires, physical injury, or stains.
- When loading batteries, observe their correct polarities as marked on the product. If loaded in the wrong direction, the batteries could explode or leak, resulting in fires, physical injury, or stains.

ATTENTION

- Do not drop or exert undue force on the remote control.
- To avoid possible failures. Do not splash the remote control with water or put it on a wet object.
- If you do not intend to use the remote control for an extended period of time, remove the batteries from it.
- If the remote control begins to lack responsiveness, replace the batteries.
- Strong light such as direct sunlight impinging on the photoreceptor of the remote control can cause operational failure. Position this unit to avoid direct contact with such light.

INSTALLATION INSTRUCTIONS

Installation

- If you have purchased the model without the pedestal attached: When installing the monitor, use the optional pedestal. The pedestal has been used for the illustrations in this manual.

CAUTION

- Use one of the special mount units to install this product. A mount of insufficient strength or inadequate design can cause overturning or dropping and result in fire, electrical shock or injury. Please note that our company assumes absolutely no responsibility for personal injuries or property damage caused by use of other mount units or improper installation.
- Installation of the wall mount unit and ceiling mount unit can be dangerous, so do not attempt this work yourself. Ask your dealer to provide the name of a qualified installer.
- In order to prevent an internal temperature increase, maintain a space of 10cm (4 inches) or more* between the sides and other objects such as walls, etc., so that the ventilation holes are not blocked. (*:)

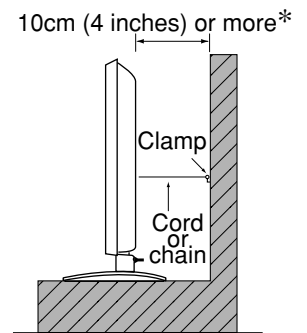

Anti-tumble measures

CAUTION

Have this unit mounted in a stable place. Take measures to prevent it from tumbling down to avoid possible physical injury.

Securing to a wall or pillar

Use a commercially available cord or chain, and a clamp to secure the set to a firm wall or pillar.

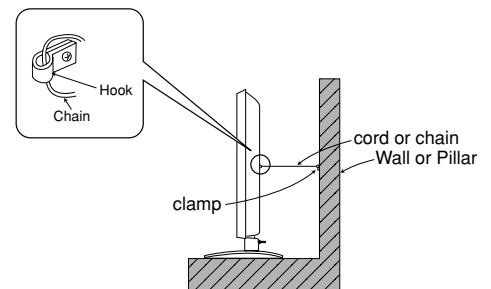

Securing to a desktop

- 1) Using wood screws (two), fasten the set to the clamping screw holes on the rear of the pedestal as shown.
- 2) Using commercially available wood screws, secure the set firmly in position.

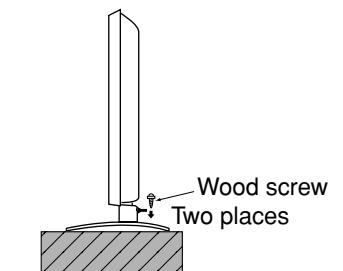

INSTALLATION INSTRUCTIONS (continued)

Read **CAUTION: READ THIS BEFORE OPERATING YOUR UNIT.** and **PRECAUTIONS** (5 to 8) carefully to ensure maximum safety before proceeding to these steps:

- Choose a safe, level location to install the product.
 - Install the monitor in a location with easy access to a power socket.
- Make sure that the power switch of this device is turned off.

Connecting to a PC

(1) Make sure that the display signal of the personal computer to be used is compatible with the specifications of this device.

- See "Product Specifications" concerning the specifications of this device. 28 ~ 30

(2) Make sure that the power switch of the personal computer is turned off.

(3) Connect the signal input terminal (RGB 1 or RGB 2) on the rear panel of this device to the display signal output terminal of the personal computer.

- Use a cable that fits the input terminal of this device and the output terminal of the personal computer.
- Depending on the type of personal computer being connected, the use of an optional conversion adapter or the adapter provided with the personal computer may be necessary in some cases. For details, refer to the instruction manual of the personal computer, or ask the personal computer manufacturer or your local retail dealer.

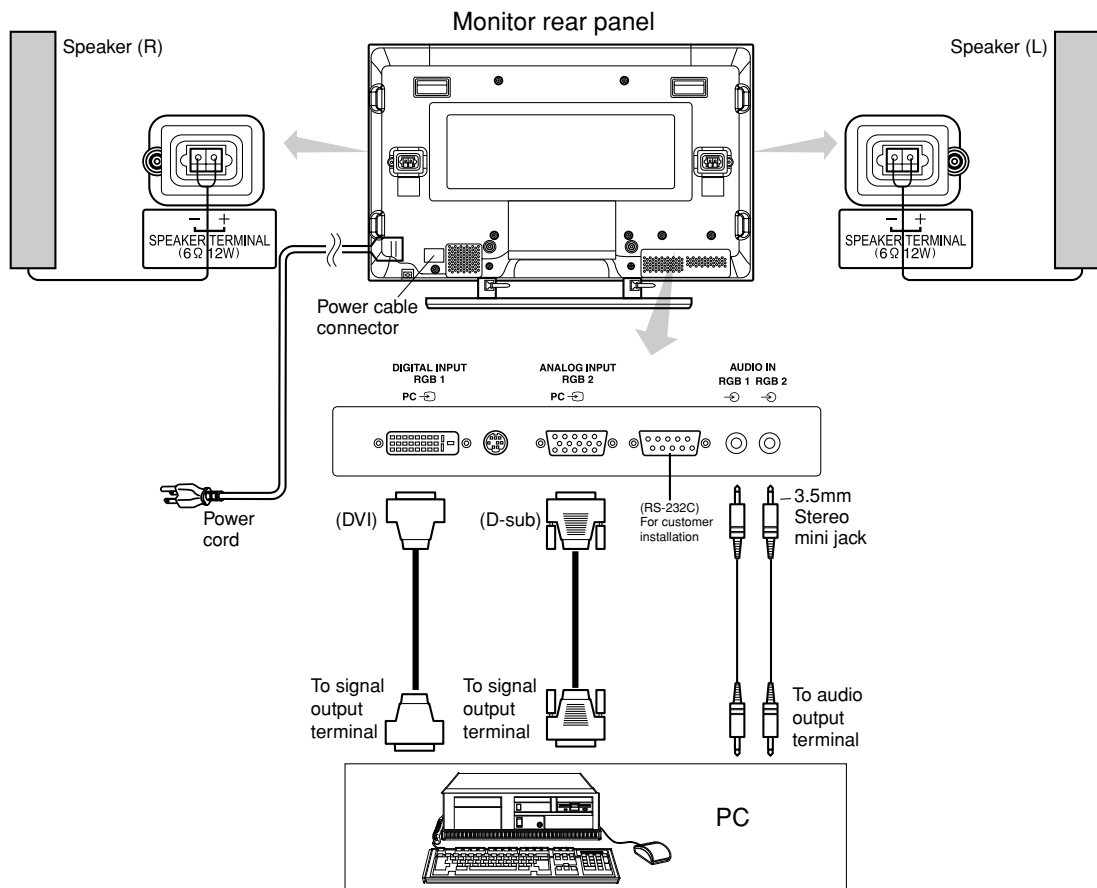

INSTALLATION INSTRUCTIONS (continued)

Power Cord Connection

Connect the power cord after completing all other connections.

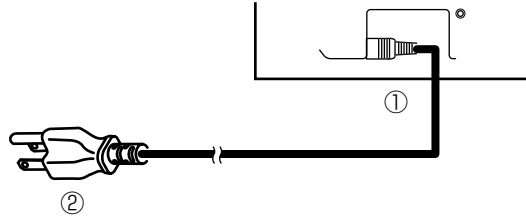

- ① Connect the power cord to this device.
- ② Connect the power cord plug to the power outlet.
(The type of plug is different from this drawing for some countries.)

CAUTION

- Use only the power cord provided.
- Do not use a power supply voltage other than that indicated (AC100-240V, 50/60Hz) as this may cause fire or electric shock.

OPERATING INSTRUCTIONS

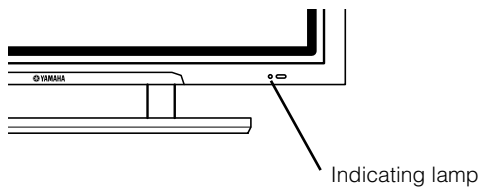

Main power switch

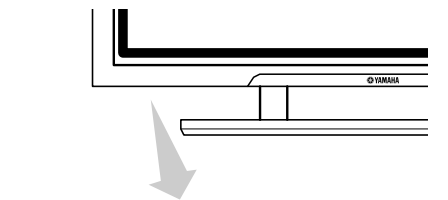
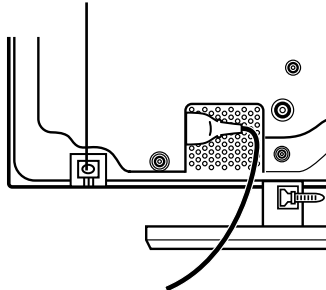

SUB-POWER button

POWER OFF button

POWER ON button

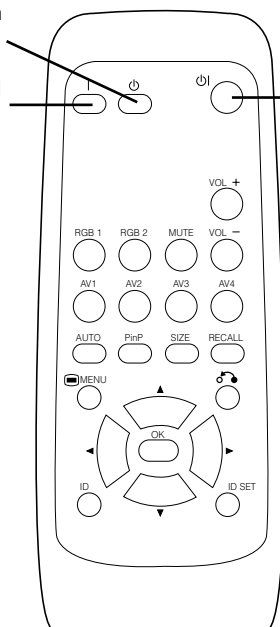

POWER ON/OFF button

Turning Power On and Off

- To turn the monitor power on, press the main power switch on the monitor main unit to ON, and then press the SUB POWER button or the ON/OFF or ON button on the remote control.
- To turn the monitor power off, press the SUB POWER button or the ON/OFF or OFF button on the remote control, and then set the main power switch on the monitor main unit to OFF.
 - During normal use, the main power switch is set in the ON position, and the monitor can then be turned ON/OFF using the SUB POWER button or the ON/OFF button on the remote control.

Indicating lamp

Indicating lamp	Power status	Operating
Off	Off	When the main power switch is set to OFF.
Lights red	Off (standby)	When the main power switch is ON, and the OFF button on the remote control or the SUB POWER button on the underside of the front of the frame is OFF.
Lights green	On	When the main power switch is ON, and the ON button on the remote control or the SUB POWER button on the underside of the front of the frame is ON.
Lights orange	Off (Power Save)	When the main power switch is ON, and the ON button on the remote control or the SUB POWER button on the underside of the front of the frame is OFF. However, the indicator also light orange when the unit is in POWER SAVE mode.

When the indicating lamp lights orange or the message "No Sync. Signal", "Power Save" or "Invalid Scan Freq." appears on the screen, see "Power Save Mode" or "Symptoms That Appear to be Failures." [23](#) [25](#)

ATTENTION

- Avoid repeatedly turning the monitor on and off at short intervals. Failures might result from such operation.
- Turn off the main power switch if you do not plan to use the monitor for an extended period of time.
- If a power failure occurs while the main unit is running, it will be powered on upon recovery from the failure. Turn off the unit main power switch before you leave the area in which the main unit is located.

OPERATING INSTRUCTIONS (continued)

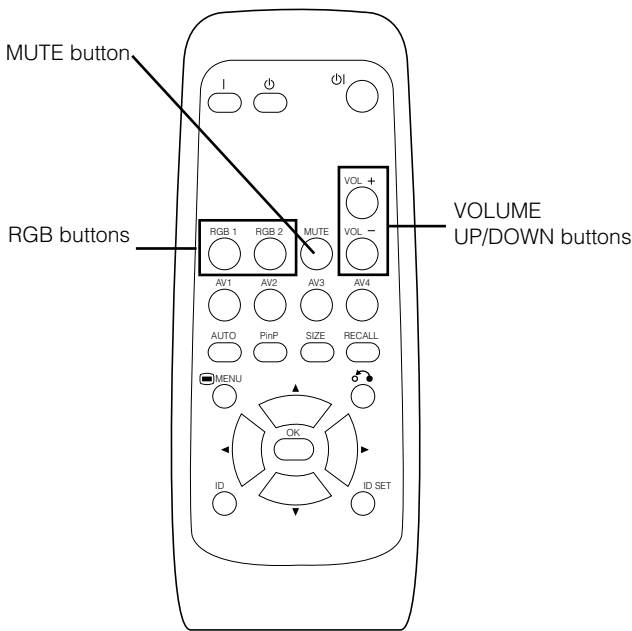
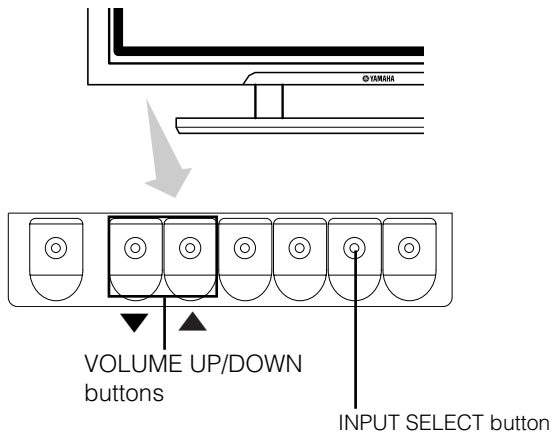

Volume Adjustment

The volume can be adjusted by pressing the VOL+ and VOL- buttons of the remote control (or the ▲ and ▼ volume buttons of the monitor unit).

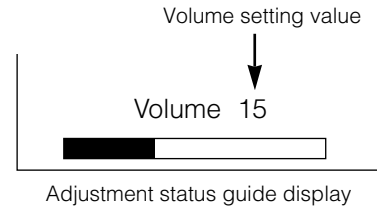

• **When a button is pressed, the volume adjustment status guide will be displayed.**

- The volume will increase when the VOL+ (or ▲) button is pressed while the guide is being displayed.
- The volume will decrease when the VOL- (or ▼) button is pressed while the guide is being displayed.

Audio Mute

The audio volume can be temporarily muted by pressing the MUTE button of the remote control.

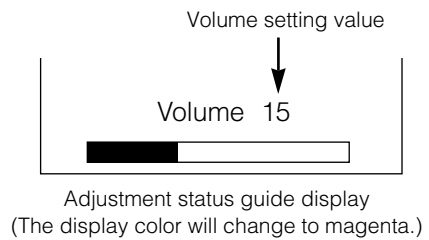

• **When a button is pressed, the volume adjustment status guide (magenta) will be displayed.**

- The volume setting can be lowered by pressing the VOL- button while the audio is mute.
- The muting can be cancelled by pressing the VOL+ button or MUTE button while the audio is mute.

When the MUTE button of the remote control is pressed again, the audio will be restored and the volume display (green) will appear.

Input Switching

- Input can be switched by pressing the RGB1, RGB2, buttons of the remote control.
- Input can be switched in the sequence of RGB1 → RGB2 by pressing the INPUT SELECT button of the monitor.



OPERATING INSTRUCTIONS (continued)

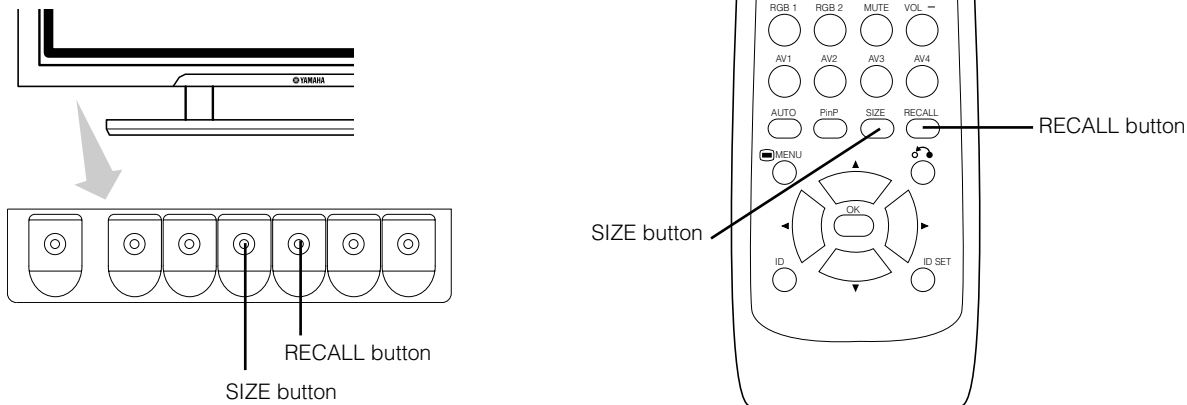

Size Switching

Each time the **SIZE** button of the remote control or the monitor is pressed, the screen display area will change in sequence and the status will be displayed at the bottom of the screen.

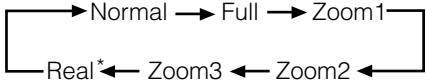

* Real mode gives an image of the same shape as it is displayed on a computer monitor. This mode is only available for VGA (640 X 480) and WVGA (864 X 480).

Display area selection diagram (RGB input)

Resolution	Circular display					
	Full display	Normal	Real	Zoom1	Zoom2	Zoom3
640 X 480 (VGA)						
800 X 600 (SVGA)						
1024 X 768 (XGA)						
1280 X 1024 (SXGA)						
1600 X 1200 (UXGA)						
			* VGA and W-VGA only			

To display signals as pictured above, the plasma monitor performs such processes as compression (thinning) and expansion. Because of this, there is a possibility that flicker may become noticeable on Zoom (1 ~ 3) depending on the display contents. If this occurs, turning the Vertical Filter On can reduce the flicker.

Input Signal Screen Display

The input signal status can be displayed on the screen by pressing the **RECALL** button of the remote control or the monitor.

- The display will go out in approximately 6 seconds.

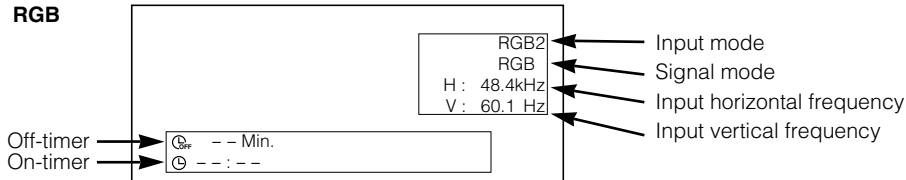

OPERATING INSTRUCTIONS (continued)

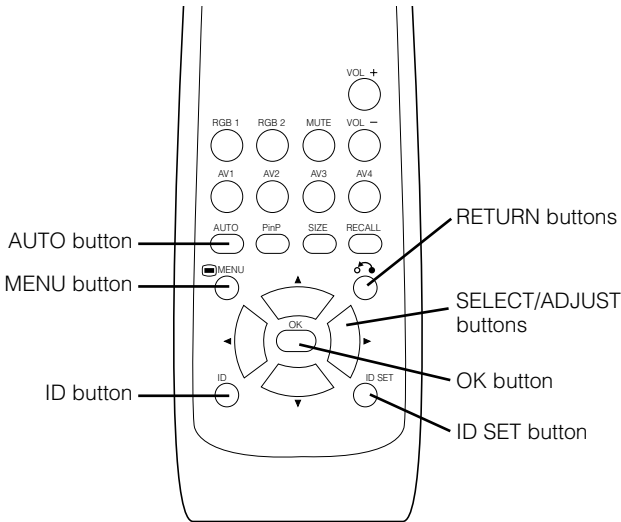

Using the Menu Screen (On-screen display system)

When the MENU button is pressed, the adjustment menu screen will be displayed; from there, PC signal adjustment and setting is possible by using the SELECT button, ADJUST button and OK button.

- Refer to [18](#) - [22](#) concerning the adjustment items and the settings.

Example: Selecting the Picture screen

1. Press the MENU button to display the Main Menu screen.

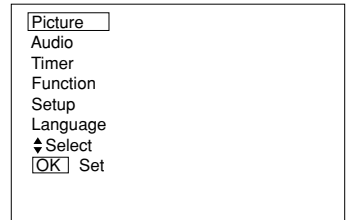
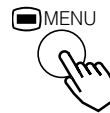

2. Press the OK button to display the Picture Menu screen. (Use the ▲ and ▼ SELECT buttons to select other items.)

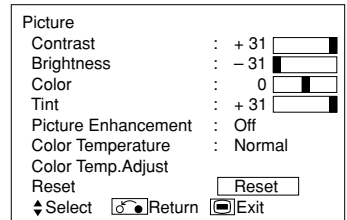
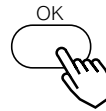

3. Use the ▲ and ▼ SELECT buttons to select the item to be adjusted and then use the ◀ and ▶ ADJUST buttons to adjust (example: Contrast).

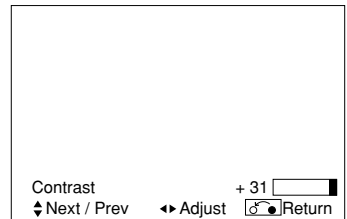
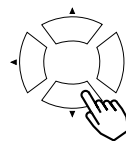

- Press the RETURN button to return to the previous screen.
- If there is no operation for a period of one minute, the Adjustment Menu screen will be closed automatically.

Automatic Adjustment of Screen Position and the Clock

Adjustment of the screen to a position suitable for the PC signal and the clock adjustment can be performed automatically by pressing the AUTO button of the remote control.

CAUTION

Perform this adjustment for each input (RGB1 or RGB2) and for each signal.

* Depending on the signal, satisfactory adjustment may not be possible in some cases. In such cases, adjust by referring to the Setup Menu item.

Independent Operation of Multiple Monitors (ID No)

Setting the ID No. of the remote control allows separate control of up to a maximum of seven monitors. Remote control ID No. 2 (initially ID no. 1) can be set by pressing the ID SET button for 2 sec. or more while holding down the ID button. The number will be incremented (2...6→7→1→2) when this button pressed continuously.

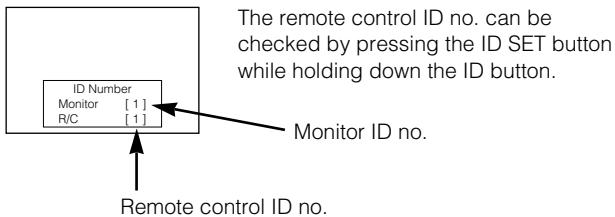

The ID remote control is operated by pressing the various buttons while holding down the ID button; Operation is possible only when the remote control and monitor ID nos. are the same.

- The remote control can be operated normally by pressing the various remote control buttons without holding down the ID button.
- Set the monitor using the ID No. of Function MENU. [20](#)

OPERATING INSTRUCTIONS (continued)

PICTURE MENU

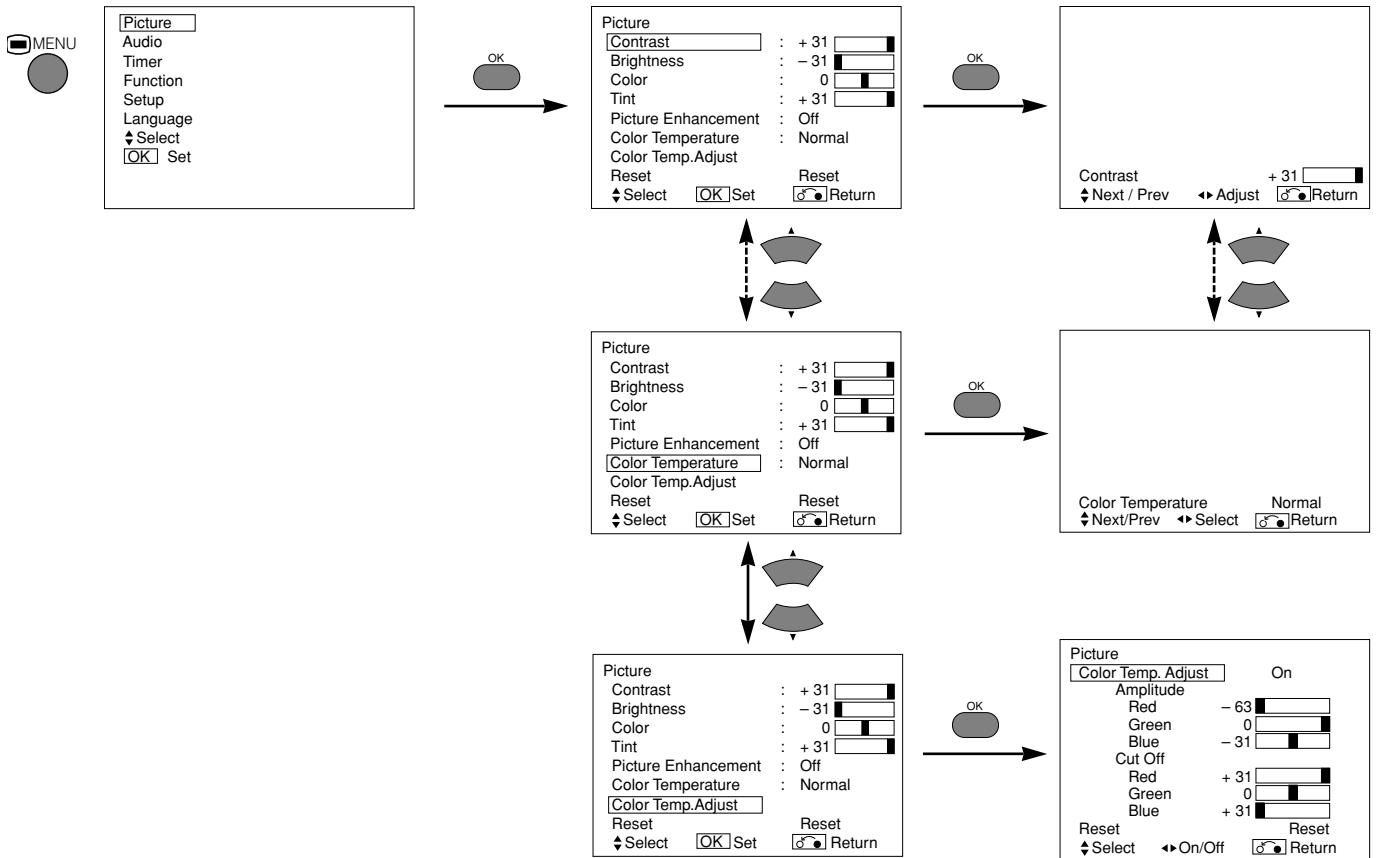

Selected characters		◀	▶	Setup hint
Contrast		Narrows the gap between brightness and darkness.	Broadens the gap between brightness and darkness.	Adjust for maximum visibility to suit the ambient brightness. Adjust further till [+40] by pressing and holding ▶ cursor button at [+31]. The color for [+32] to [+40] numbers will change from white to magenta. This special mode is better for dark scenes. For brighter scene some parts of the picture might not be clear. We recommend to set at [+31]. "Panel Life" in the Function Menu should be set to Normal when Contrast setting is adjusted.
Brightness		Black is subdued for increased overall darkness.	Black is set off for increased overall brightness.	Adjust to taste.
Color		Darkens colors.	Lightens colors.	Adjust to taste.
Tint		Enhances red and weakens green.	Enhances green and weakens red.	This is not available for adjustment when receiving PAL/SECAM signal. In this case the character will be grayed out. Adjust for the most realistic skin color.
Picture Enhancement		Off ↔ Low ↔ Middle ↔ High		Sets the clarity of small details to the desired level.
Color Temperature		Cool ↔ Normal ↔ Warm ↔ Black / White		Normally set to Normal.
Color Temp. Adjustment		→ Off ↔ On ←		Turn On when you wish to change color temperature to suit user preferences.
Amplitude	Red	Brighter scenes are decreased in reddish color.	Brighter scenes are increased in reddish color.	Adjust color temperature to suit user preference. These settings are independently stored in each of the 4 Color Temperature modes.
	Green	Brighter scenes are decreased in greenish color.	Brighter scenes are increased in greenish color.	
	Blue	Brighter scenes are decreased in bluish color.	Brighter scenes are increased in bluish color.	
Cut Off	Red	Dark scenes are decreased in reddish color.	Dark scenes are increased in reddish color.	
	Green	Dark scenes are decreased in greenish color.	Dark scenes are increased in greenish color.	
	Blue	Dark scenes are decreased in bluish color.	Dark scenes are increased in bluish color.	
Reset			(Selects the Reset mode)	The original factory settings for the items of this Menu page can be restored by pressing the OK button.

OPERATING INSTRUCTIONS (continued)

AUDIO MENU

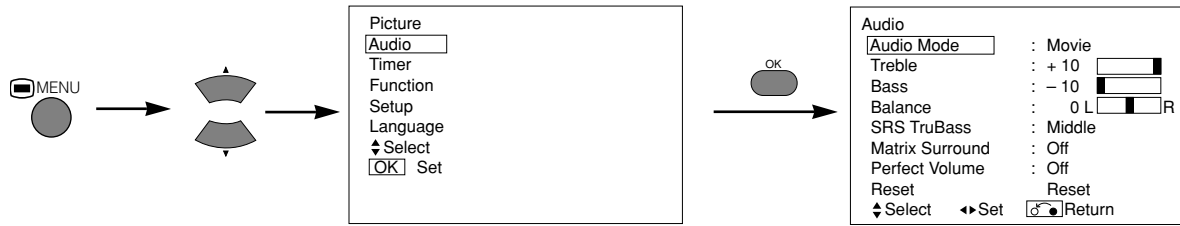

Selected characters			Setup hint
Audio Mode			Movie: This selects the audio mode suitable for Movies. Music: This selects the audio mode suitable for Music. Speech: This selects the audio mode suitable for News, Talk show etc. Favorite: This mode should be adjusted to suit your preference.
Treble	Suppresses treble.	Enhances treble.	Adjust to taste.
Bass	Suppresses bass.	Enhances bass.	Adjust to taste.
Balance	Suppresses right-side sound.	Suppresses left-side sound.	Adjust to taste.
SRS TruBass			SRS TruBass takes advantage of the ability of the human ear to distinguish between two different tones. By using this ability, TruBass gives enhanced bass sound that otherwise would not be heard. Adjust it depending on the user's preference.
Matrix Surround			This features the spacious sound effects of a stadium.
Perfect Volume			This will automatically adjust volume so each channel and input has the same average volume level.
Reset		(Selects the Reset mode)	The original factory settings for the items of this Menu page can be restored by pressing the OK button.

TIMER MENU

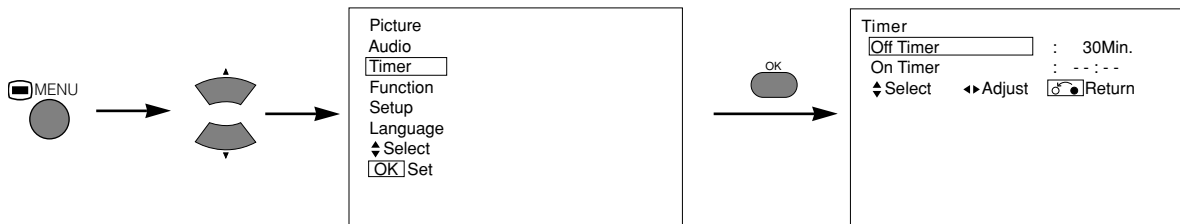

Selected characters			Setup hint
Off Timer			This function automatically sets the power to standby status when the indicated time period has elapsed.
On Timer	-- (: --) hours	(- - : -) minutes	This automatically sets the power from standby to ON when the indicated time period has elapsed. The settable time is 00:00~11:59. Input the required time by ▼▲ SELECT buttons on the remote control.

OPERATING INSTRUCTIONS (continued)

FUNCTION MENU

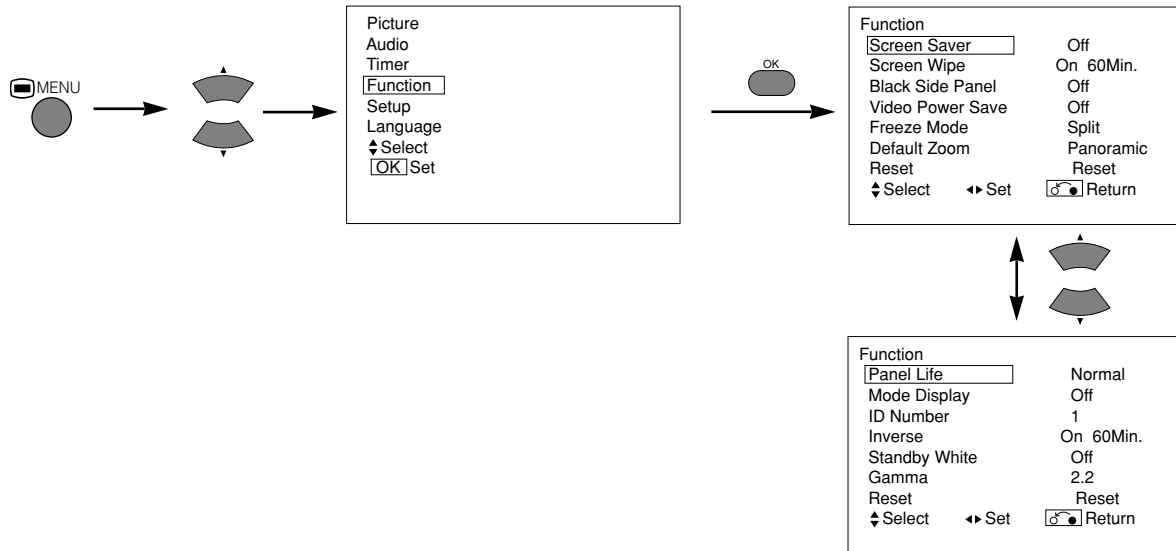

Selected characters	◀	▶	Setup hint
Screen Saver	◀ Off ↔ 5Min. ↔ 10Min. ↔ 60Min. ↔ 40Min. ↔ 20Min. ▶		This moves the picture around the screen in small amounts, at set intervals, to reduce the panel image retention. Image retention occurs when stationary objects, such as screen logos, leave a slight image visible after they should have disappeared.
Screen Wipe	On	60Min.	This is used to reduce the panel image retention that can occur with stationary pictures by displaying a completely white screen. Select On (continuous operation) or 60 Min. (time limit operation) and press the OK button. Press the MENU or RETURN button on the remote control to return to normal viewing.
Black Side Panel	▶ Off ↔ On ▶		This turns the gray sidebars On/Off when watching normal mode screen size area. It is always set to Off when the monitor is powered On. It is recommended to set Black Side Panel to off to reduce the panel image retention.
Video Power Save			Optional (grayed out)
Freeze Mode			Optional (grayed out)
Default Zoom			Optional (grayed out)
Reset		(Selects the Reset mode)	The original factory settings for the items of this Menu page can be restored by pressing the OK button.
Panel Life	Normal ↔ Extend 1 ↔ Extend 2		This function suppresses the contrast of the screen regardless of the Contrast setting in the Picture Menu. By this control, power consumption can be reduced or degradation of a panel can be mitigated. The order of power consumption is Extend 2 < Extend 1 < Normal. If the Contrast setting is changed when this item is set to Extend 1 or 2, it will be changed to Normal automatically.
Mode Display	▶ Off ↔ On ▶		This function displays the Input Signal Screen Display every time the input mode and signal mode are changed. Set to OFF if the Input Signal Screen Display is not needed when switching signals.
ID Number	1 ↔ 2 ↔ 3 ↔ 4 7 ↔ 6 ↔ 5		Assigns ID nos. to the monitors so that they can be controlled individually (up to 7 monitors can be controlled).
Inverse	On	60Min.	This function changes each level of RGB signal invert to reduce the panel image retention. When this function is required, select On (continuous operation) or 60Min. (time limit operation) and press the OK button. And press the Menu or Return button to exit.
Standby White	▶ Off ↔ 15Min. ↔ 30Min. ↔ 120Min. ↔ 60Min. ▶		This function is also provided to prevent image retention. If time is set for this item, the screen changes into a white pattern when the monitor enters power save mode, and continues for the period of setting time.
Gamma	▶ 2.2 ↔ 2.8 ▶		Normally set to 2.2.

OPERATING INSTRUCTIONS (continued)

SETUP MENU

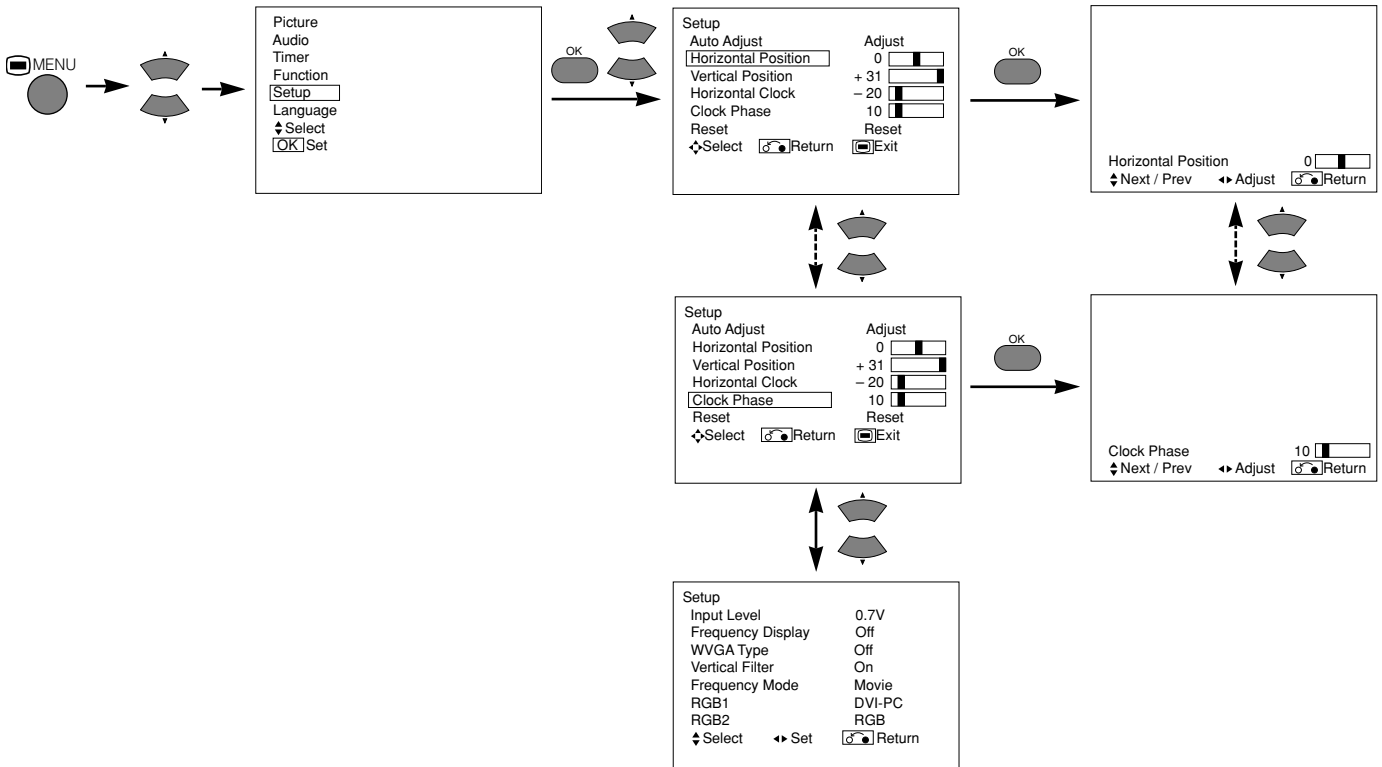

Selected characters	◀	▶	Setup hint
Auto Adjust*	(Menu)	(Adjust) Press the OK button to start automatic regulation.	Horizontal Position, Vertical Position, Horizontal Clock and Clock Phase are adjusted automatically.
Horizontal Position	Moves the horizontal position to left. 	Moves the horizontal position to right. 	Adjust the left-side display position. (This function is only for RGB2. It is not available (grayed out) for RGB1.)
Vertical Position	Moves down the vertical position. 	Moves up the vertical position. 	Adjust the vertical display position. (This function is only for RGB2. It is not available (grayed out) for RGB1.)
Horizontal Clock	Reduces the dot clock frequency (shrinks the right side). 	Increases the dot clock frequency (expands the right side). 	Adjust for maximum character clarity. (This function is only for RGB2. It is not available (grayed out) for RGB1.)
Clock Phase	Slows the dot clock phase (shifts slightly to left). 	Advances the dot clock phase (shifts slightly to right). 	Adjust for clear character visibility. (This function is only for RGB2. It is not available (grayed out) for RGB1.)
Reset		(Selects the Reset mode)	The original factory settings for the items of this Menu page can be restored by pressing the OK button. (This is effective only for RGB2.)
Input Level			Normally set to 0.7 V. If white is found to spread across the screen, set to 1.0 V. (This is effective only for RGB2.)
Frequency Display			Set this to Off if the frequency information of the Input Signal Screen Display is not required.
WVGA Type			This is only available for W-VGA signal. When it is set to On, the display area mode can be selected Full or Real.
Vertical Filter			Turn On when concerned about screen flicker.
Frequency Mode			Set to Movie when viewing moving images on a personal computer.
RGB1	Optional (grayed out)		
RGB2	Optional (grayed out)		

* Depending on the type of signal displayed, displays may not be optimized through automatic adjustment. Adjust manually to optimize them.

OPERATING INSTRUCTIONS (continued)

LANGUAGE MENU

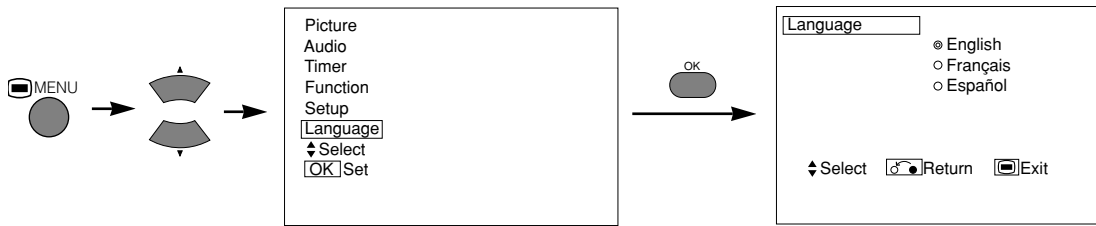

Select a language using the ▼ ▲ SELECT buttons and press the OK button.

OTHER FEATURES

Automatic Store

Approximately 1 sec. after adjustment is completed, the adjustments will be recorded as shown in the table below.

Menu	Display	Registration condition
Picture	Contrast	For every input function, 1 setting is registered.
	Brightness	
	Color	
	Tint	
	Picture Enhancement	
	Color temperature	
	Color Temp. Adjust	
	R Amplitude	
	G Amplitude	
	B Amplitude	
	B Cut Off	
Audio	Audio Mode	1 setting is registered.
	Treble	For every Audio Mode, 1 setting is registered.
	Bass	
	Balance	1 setting is registered.
	SRS TruBass	For every Audio Mode, 1 setting is registered.
	Matrix Surround	
	Perfect Volume	

Menu	Display	Registration condition	
Function	Screen Saver	1 setting is registered.	
	Screen Wipe	(not registered)	
	Black Side Panel	(not registered)	
	Panel Life	1 setting is registered.	
	Mode Display		
	ID Number		
	Inverse		
	Standby White		
	Gamma		
	Setup	Auto Adjust	(not registered)
		Horizontal Position	For every signal Mode, 1 setting is registered. (Only for RGB2)
Vertical Position			
Horizontal Clock			
Clock Phase			
Input Level		1 setting is registered.	
Frequency Display			
WVGA Type			
Language	Vertical Filter	1 setting is registered.	
	Frequency Mode		

- The previously recorded items will be lost.
- The signal mode can be identified by the horizontal/vertical sync frequency and the sync signal polarity. Different signals for which all the elements are the same or similar will be handled as the same signal.

OTHER FEATURES (continued)

Signal Check

Changes in the signal status are displayed on the screen as they arise.

Status	Display	Action
When Mode Display is set to ON, the input signal is switched or when the RECALL button is pressed.	A guide is displayed for the input terminal and the horizontal and vertical sync frequency.	_____
When the sync signal is no longer detected.	<ul style="list-style-type: none"> A guide displays No Sync. Signal, and Power Save (for approx. 5 sec.) When the condition continues and the sync signal cannot be detected, the indicator lamp of the power source changes in orange and the mode switches to power save mode. 	Recheck the personal computer power switch status and the connection status.
When the input signal does not match the monitor specifications or is in an unstable state.	"Invalid Scan Freq" appears on the display panel.	Recheck the input signal specifications. 28 ~ 30

RGB

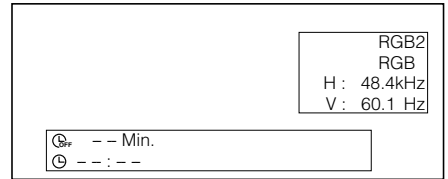

Power Save Mode

When the RGB1, RGB2 input is selected

- When this unit is connected to a VESA DPMS computer, the Power Save (Off) mode can be set to be activated automatically when the computer is not being used to reduce power consumption by this unit.

RGB sync signal	Horizontal	Yes	No	Yes	No
	Vertical	Yes	Yes	No	No
PC signal		Active (normal display)	Blank (no display)		
Operation mode		On	Off		
Indicating lamp		Lights green	Lights orange		
Power consumption		365W	3W or less (RGB1) 1W or less (RGB2 ; 100V ≤ AC ≤ 120V) 3W or less (RGB2 ; 120V < AC ≤ 240V)		

Returning to operating status

- Operate the personal computer, or press either the INPUT SELECT button of the main unit or the RGB1/RGB2 buttons of the remote control to return the unit to power on mode.

IMAGE RETENTION OF PLASMA DISPLAY PANEL

There are different characteristics that result in panel image retention depending on how the plasma monitor is used. Situations and effective usage methods related to ghosting are provided below.

Image retention characteristics of a plasma display panel

The image retention phenomenon of a plasma display panel occurs due to partial phosphor degradation arising from partial character and figure display.

For example, when the character image as shown in Fig. A at the right is continuously displayed for a long period of time, the only part of the phosphor (Red, Green, Blue) that will degrade will be the color of the applicable character display portion. Consequently, when a white image is displayed on the entire screen as shown in Fig. a, the character marks displayed up to that time will become a color difference visible to the eye, but the phosphor will never burn.

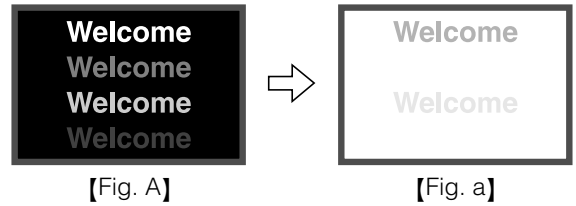

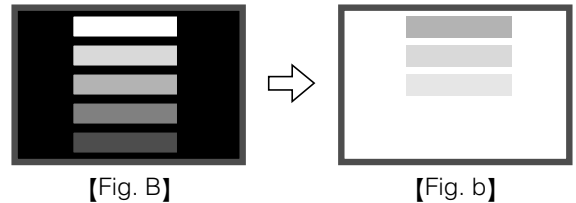

■ The degree of image retention is proportional to the brightness of the characters and figures displayed as well as the display time.

- The tendency of the phosphor is to degrade more the brighter the characters and figures are displayed. When images of figures with different levels of brightness, as shown in Fig. B, are continuously displayed for a long period of time, it becomes easier for image marks at locations when the brighter figures are displayed to be noticeable.



* The image retention images in this document are exaggerated for the purpose of explanation. The actual manner in which the image retention is seen differs depending on the operation time and brightness.

Methods to Reduce the Occurrence of Image Retention

- Lower the Contrast and Brightness settings of the plasma display panel as much as possible.
A function is provided in the display that allows you to control the brightness of the screen to reduce degradation of the panel. Using this function makes it possible to reduce image retention.
(Refer to Panel Life (Extend 1.or Extend 2 shown on )
- Set the plasma monitor to an "Screen Wipe" or "Inverse" display.
The occurrence of image retention when displaying images of identical patterns, such as static images, for long periods of time can be reduced by displaying a reversed color or completely white screen for about 1 ~ 2 hours after terminating the display.
(Settings can be made using Screen Wipe and Inverse of Function MENU shown on )
- Using in combination with moving images
Since the degradation of the fluorescent material progresses comparatively uniformly for moving images, the occurrence of partial image retention can be controlled. We recommend using the plasma monitor in combination with moving images such as those of DVD playback.
* Please be careful since image retention will occur if display is left in a two screen display state for a long period of time.
* Television broadcasts include images displayed for long periods of time in which the left and right or top and bottom of the image are cut and broadcast station name or time are displayed for a long period of time at the same portion of the screen. Image retention in these portions can be expected to occur, so please be aware.

NOTES

About screen defects

- High precision technology is used in the making of plasma display panel but there may be dark spots (points that do not illuminate) and bright spots (points that are too bright) in some cases. These do not indicate a malfunction.

About residual images

- In some cases, residual images may remain after the short-term display of still images and another image is displayed, but these will disappear and return to normalcy. This is not a malfunction.

About the panel screen

- Plasma display panels display images by means of electrical discharges inside the panel. Because of this, the temperature of the panel surface may rise in some cases. Also, plasma display panels are made of finely processed glass. A reinforced glass filter is installed over the panel surface but avoid strong impact because there is still danger of glass breakage.













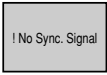

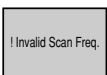



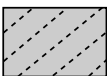

TROUBLESHOOTING

Symptoms That Appear to be Failures

Make the checks suggested below depending on the symptoms observed. If the symptoms remain uncorrected, contact your dealer.

CAUTION

Customer servicing can be hazardous.

Symptom	Point to check	See page
<ul style="list-style-type: none"> No picture with the power-indicating lamp off. 	<ul style="list-style-type: none"> Check the way the power cable is connected. Press the power switch. 	 13  14
<ul style="list-style-type: none"> The message "No Sync. Signal" or "Power Save" is displayed. No picture, with the power indicating lamp lit orange.  	<p>No sync signal is detected.</p> <ul style="list-style-type: none"> Check the way the signal cable is connected. Make sure that the switch of the computer, imaging equipment, etc., is turned on. Make sure the computer is not in the power-save mode. Check to see if the input selection matches the connection terminal. 	 12
<ul style="list-style-type: none"> The message "Invalid Scan Freq." is displayed. 	<p>An input signal is not received normally.</p> <ul style="list-style-type: none"> Check to see if the input signal matches the monitor specifications. Check the way the signal cable is connected. 	 12  29  30
<ul style="list-style-type: none"> The power indicating lamp is lit normally but no picture displays. 	<ul style="list-style-type: none"> Check the contrast and brightness settings (adjust them for higher contrast and brightness). Check the way the signal cable is connected. 	 18  12
<ul style="list-style-type: none"> The display image appears flowing slantwise. Text displayed across the screen appears vertically streaked, with the characters in vertical columns blurred.  	<ul style="list-style-type: none"> Adjust the dot clock frequency and phase. (Adjust the dot clock frequency first, the dot clock phase next.) (RGB input) 	 21  27
<ul style="list-style-type: none"> Text displayed across the screen appears blurred. A fine pattern flickers when displayed on the screen.  	<ul style="list-style-type: none"> Adjust the dot clock phase for the clearest viewing. (RGB input) 	 21  27
<ul style="list-style-type: none"> The remote control does not work. 	<ul style="list-style-type: none"> Check to see if the batteries are loaded in the remote control in opposite direction. Check to see if the batteries in the remote control are OK. Check if the setting of remote control ID no. is correct. 	 10  17

TROUBLESHOOTING (continued)

Symptoms That Appear to be Failures (continued)

Symptom	Point to check	See page
<ul style="list-style-type: none"> The temperature of the display panel surface is high. 	<ul style="list-style-type: none"> Plasma display panel is lighting the phosphors in the display panel by the discharge of internal radiation. In some cases, this may cause the temperature of the panel surface to increase. Please note that this is not a malfunction. 	-
<ul style="list-style-type: none"> There are points (*) on the screen that differ in color from the periphery of the screen. *Points that do not light, points with brightness different from that of the periphery, points with color different from that of the periphery, etc. 	<ul style="list-style-type: none"> High-precision technology is used to manufacture the plasma display panel. However in some cases, there are minor defects in some parts of the screen. Please note that this is not a malfunction. 	-
<ul style="list-style-type: none"> Vertical stripes appear, depending on the screen contents. 	<ul style="list-style-type: none"> The plasma display panel is lighting the phosphors by the discharge of internal radiation. Depending on the screen contents, in rare cases this may cause vertical stripes to appear because of failure to light. Please note that this is not a malfunction. 	-
<ul style="list-style-type: none"> Coarse horizontal stripes appear in FULL display. 	<ul style="list-style-type: none"> Adjusting the Clock Phase will reduce the horizontal stripes. (RGB input) 	21
<ul style="list-style-type: none"> Flickering in the form of horizontal lines oscillating up and down. (PC INPUT MODE only) 	<ul style="list-style-type: none"> If the direct frequency from the computer is below 85Hz, try a higher frequency (upper limit 85Hz). There may be a slight attenuation of the current image. Try turning the Vertical Filter On. For this case however, the vertical resolution will drop. 	21
<ul style="list-style-type: none"> The top of the monitor heats up. 	<ul style="list-style-type: none"> When used for long periods of time, the top of the monitor may heat up. This is not a malfunction. 	-
<ul style="list-style-type: none"> Text characters are displayed with varying thicknesses. 	<ul style="list-style-type: none"> The thicknesses of characters and lines may vary if images with a vertical resolution greater than 512 lines are displayed; however, this is not a malfunction. 	-

TROUBLESHOOTING (continued)

Actions to Correct Abnormal Displays

Depending on the kind of system equipment used, images may not be displayed normally. In this case, make the adjustments suggested below. (only for RGB2)



Symptom 1	Text displayed across the screen appears vertically streaked, with some characters blurred (figure 1). The display image appears flowing (figure 2) (RGB input).
Example	<p>Figure 1</p> <p>Vertical streaks</p> <p>Before adjustment Some characters are blurred.</p> <p>After adjustment All characters appear crisp now.</p> <p>After adjustment All characters are blurred.</p>
Adjustment procedure	<p>1) Press the AUTO button on the remote control.</p> <p>When adjustment is not possible with Auto Adjust</p> <p>2) Press the MENU button. The Main Menu will be displayed.</p> <p>3) Press the ▼ SELECT button and select Setup.</p> <p>4) Press the OK button. The Setup Menu will be displayed.</p> <p>5) Press the ▼ SELECT button and select Horizontal Clock.</p> <p>(Display fine patterns as characters or a vertical striped pattern over the entire screen during Horizontal Clock adjustment.)</p> <p>6) Press the ► or ◀ ADJUST buttons and search for clear characters over the entire screen.</p> <p>7) Perform adjustment for symptom 2 below, when the characters are blurred on the entire screen.</p>

• The display image may be momentarily disturbed during clock adjustment but this is not a failure.

Symptom 2	Text displayed across the screen appears blurred in its entirety (figure 2). A fine pattern flickers when displayed on the screen (figure 3).	
Example	<p>Figure 2</p> <p>Before adjustment</p> <p>After adjustment</p>	<p>Figure 3</p> <p>Before adjustment</p> <p>After adjustment</p>
Adjustment procedure	<p>1) Press the AUTO button on the remote control.</p> <p>When adjustment is not possible with Auto Adjust</p> <p>2) Press the MENU button. The Main Menu will be displayed.</p> <p>3) Press the ▼ SELECT button and select Setup.</p> <p>4) Press the OK button. The Setup Menu will be displayed.</p> <p>5) Press the ▼ SELECT button and select Clock Phase.</p> <p>(Display fine patterns as characters or a vertical striped pattern over the entire screen during Clock Phase adjustment.)</p> <p>6) Press ► or ◀ ADJUST buttons to make the text appear clean across the screen.</p> <p>6) Press ► or ◀ ADJUST buttons to make the text appear without flickering.</p>	

PRODUCT SPECIFICATIONS

Product specifications and designs are subject to change without notice.

Panel	Display dimensions	Approx. 42 inches (922 (H) x 522 (V) mm, diagonal 1059mm)
	Resolution	1024 (H) x 1024 (V) pixels
Net dimensions (excluding pedestal)		1030 (W) x 636 (H) x 91 (D) mm
Net weight (excluding pedestal)		34.9kg
Ambient conditions	Temperature	Operating : 5°C to 35°C, Storage : 0°C to 40°C
	Relative humidity	Operating : 20% to 80%, Storage : 20% to 90% (non-condensing)
Power supply		AC100 - 240V, 50/60Hz
Power consumption/at standby		365W / <3W
Audio output		12W + 12W (6Ω)
(RGB input)		
Input signals	Input terminals	RGB1 DVI input terminal (DVI-D) RGB1 audio input terminal (3.5mm Stereo Mini Jack) RGB2 analog RGB input terminal (D-sub 15-pin) RGB2 audio input terminal (3.5mm Stereo Mini Jack)
	Video signals	0.7 V/1.0 Vp-p, analog RGB (Recommended Signal)
	Sync signals	H/V separate, TTL level [2KΩ] H/V composite, TTL level [2KΩ] Sync on green, 0.3 Vp-p [75Ω]
Recommended signal		43 modes  

- The monitor takes at least 30 minutes to attain optimal picture quality.

Signal Input

RGB terminal (D-sub 15-pin connector)

Pin	Input signal
1	R
2	G or sync on green
3	B
4	No connection
5	No connection
6	R.GND
7	G.GND
8	B.GND
9	No connection
10	GND
11	No connection
12	[SDA]
13	H. sync or H/V composite sync
14	V.sync. [V.CLK]
15	[SCL]

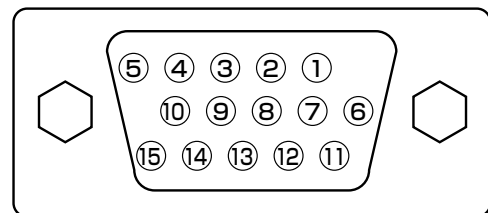

- When different kinds of input signals are simultaneously input to the monitor via a graphics board or the like, the monitor will automatically select the signals in the following priority order:

Sync signal type	Priority
H/V separate sync.	1
H/V composite sync.	2
sync.on Green *	3

*Even in the case of the recommended signals shown on the following page, there may be instances when correct display is not possible. In this case, use H/V separate sync, H/V composite sync.

PRODUCT SPECIFICATIONS (continued)

Signal Input (continued)

DVI terminal (DVI-D)

Pin	Input signal	Pin	Input signal
1	T.M.D.S. Data2-	14	+5V Power
2	T.M.D.S. Data2+	15	Ground (for+5V)
3	T.M.D.S. Data2/4 Shield	16	Hot Plug Detect
4	T.M.D.S. Data4-	17	T.M.D.S. Data0-
5	T.M.D.S. Data4+	18	T.M.D.S. Data0+
6	DDC Clock	19	T.M.D.S. Data0/5 Shield
7	DDC Data	20	T.M.D.S. Data5-
8	No Connect	21	T.M.D.S. Data5+
9	T.M.D.S. Data1-	22	T.M.D.S. Clock Shield
10	T.M.D.S. Data1+	23	T.M.D.S. Clock+
11	T.M.D.S. Data1/3 Shield	24	T.M.D.S. Clock-
12	T.M.D.S. Data3-	Frame	GND
13	T.M.D.S. Data3+		

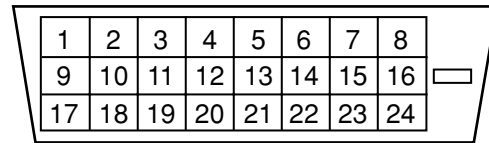

Recommended Signal List

With Digital RGB signal input (RGB1 input)

No.	Signal mode			Horizontal frequency (kHz)	Dot clock frequency (MHz)	Remarks
	Signal Name	Resolution	Vertical frequency (Hz)			
1	VGA	640 X 400	70.08	31.47	25.18	
2		640 X 480	59.94	31.47	25.18	
3	W-VGA	864 X 480	59.94	31.47	34.24	WVGA type : On
4	VESA	640 X 480	72.81	37.86	31.50	
5		640 X 480	75.00	37.50	31.50	
6		640 X 480	85.01	43.27	36.00	
7		800 X 600	56.25	35.16	36.00	
8		800 X 600	60.32	37.88	40.00	
9		800 X 600	72.19	48.08	50.00	
10		800 X 600	75.00	46.88	49.50	
11		800 X 600	85.06	53.67	56.25	
12		1024 X 768	60.00	48.36	65.00	
13		1024 X 768	70.07	56.48	75.00	
14		1024 X 768	75.03	60.02	78.75	

- Make sure that the signal of the equipment to be connected is compatible with the specifications on this list.

PRODUCT SPECIFICATIONS (continued)

Recommended Signal List (continued)

With Analog RGB signal input (RGB2 input)

No.	Signal mode			Horizontal frequency (kHz)	Dot clock frequency (MHz)	Remarks
	Signal Name	Resolution	Vertical frequency (Hz)			
1	VGA	640 X 400	70.08	31.47	25.18	
2		640 X 480	59.94	31.47	25.18	
3	W-VGA	864 X 480	59.94	31.47	34.24	WVGA type : On
4	VESA	640 X 480	72.81	37.86	31.50	
5		640 X 480	75.00	37.50	31.50	
6		640 X 480	85.01	43.27	36.00	
7		800 X 600	56.25	35.16	36.00	
8		800 X 600	60.32	37.88	40.00	
9		800 X 600	72.19	48.08	50.00	
10		800 X 600	75.00	46.88	49.50	
11		800 X 600	85.06	53.67	56.25	
12		1024 X 768	60.00	48.36	65.00	
13		1024 X 768	70.07	56.48	75.00	
14		1024 X 768	75.03	60.02	78.75	
15		1024 X 768	85.00	68.68	94.50	
16		1152 X 864	75.00	67.50	108.00	
17		1280 X 1024	60.02	63.98	108.00	
18		1280 X 1024	75.03	79.98	135.00	
19		1280 X 1024	85.02	91.15	157.50	
20		1600 X 1200	60.00	75.00	162.00	
21		1600 X 1200	75.00	93.75	202.50	
22	1600 X 1200	85.00	106.25	229.50		
23	Macintosh	640 X 480	66.67	35.00	30.24	
24		832 X 624	74.55	49.72	57.28	
25		1024 X 768	74.93	60.24	80.00	
26		1152 X 870	75.06	68.68	100.00	
27	W-XGA	1280 X 768	59.833	47.986	81.00	
28		1280 X 768	69.997	56.137	94.760	

- The type of video board or connecting cable used may not allow for correct display adjustment of Horizontal Position, Vertical Position, Horizontal Clock and Clock Phase.
- The monitor may fail to display an animation image correctly when a signal having a vertical frequency of 85Hz or higher is input to it.
- The monitor differentiates signal modes according to the horizontal and vertical frequencies and the horizontal and vertical sync signal polarities. Note that different signals having all these elements alike may be handled as the same signal.
- Displaying images with more than 512 lines of vertical resolution at Full display (compressed display) can result in the interpolation of stripes.

SUPPLEMENT

Optional Video Unit Function

Additional functions when the optional video unit is installed are as follows: (32 ~ 43)

INSTALLATION INSTRUCTIONS

Connecting to a Video Imaging Device

- (1) Make sure that the power switch of the monitor is turned off.
- (2) Make sure that the power switch of the imaging device is turned off.
- (3) Use a commercially available cable and connector to connect the signal input terminal on the rear panel of this device and the signal output terminal of the imaging device.

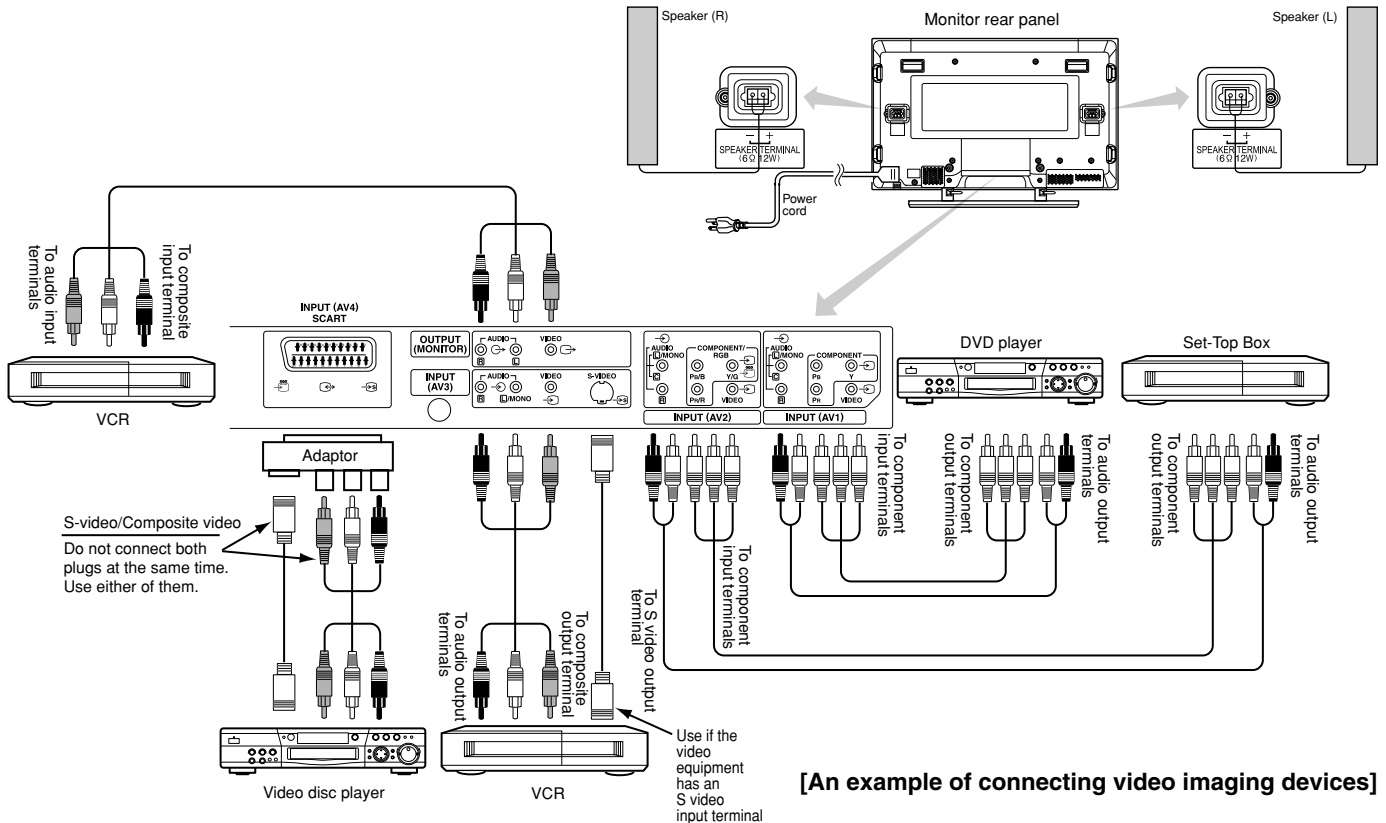

DVI-STB and RGB component setup

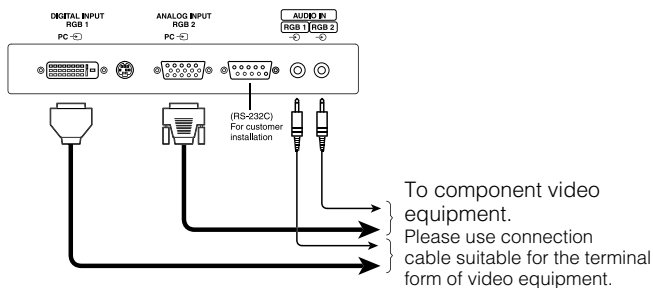

- If video equipment with an S video output terminal is used, connection with S video cable is recommended to provide finer video quality. (If the S video input terminal and the video input terminal of AV3 connect to the monitor at the same time, S video input would govern.)
- If the OUTPUT (MONITOR) terminal is connected to an external monitor with a 75 Ohm terminal, it is possible to view the same image as on the main unit. But it is possible to monitor only the composite video signal from AV1, AV2, AV3 or AV4 input that is displayed on the screen at the time.
- If the adaptor (included) is applied to AV4 input as shown in the drawing, it is impossible to receive RGB signal.

Applicable video signals for each input terminal (See PRODUCT SPECIFICATIONS for details. 41)

Terminal	RCA/SCART				DVI		D-sub		Remarks
	CVBS	S-video	Component	RGB	PC	STB	RGB	Component	
AV1	○		○						
AV2	○		○	○					Refer to Setup Menu. 39
AV3	○	○							
AV4	○	○		○					Refer to Setup Menu. 39
RGB1					○	○			Refer to Setup Menu. 40
RGB2							○	○	Refer to Setup Menu. 40

(○ : Available)

OPERATING INSTRUCTIONS

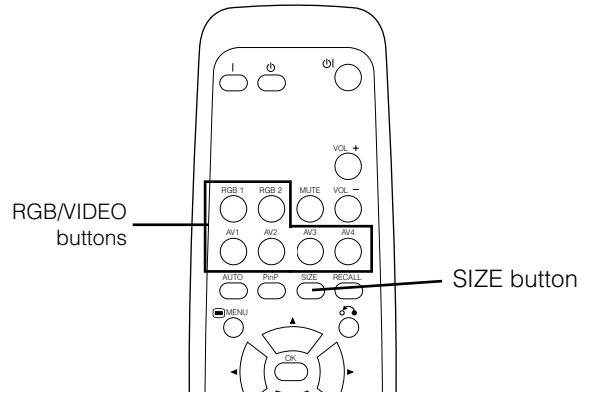
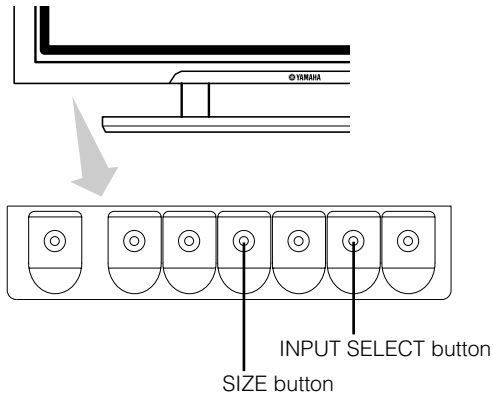

Input Switching

- Input can be switched by pressing the AV1, AV2, AV3, AV4, RGB1 or RGB2 buttons of the remote control.
- Input can be switched in the sequence of AV1 → AV2 → AV3 → AV4 → RGB1 → RGB2 by pressing the INPUT SELECT button of the monitor.

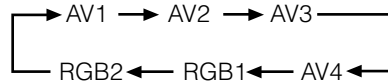

Size Switching

Each time the SIZE button of the remote control or the monitor is pressed, the screen display size will change in sequence and the status will be displayed at the bottom of the screen.

- During VIDEO signal input (AV1, AV2, AV3, AV4, RGB1 (set to [DVI-STB]) and RGB2 (set to [Component]))

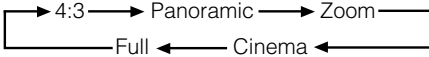

- The size will be fixed Full mode and not change when receiving the component signal of 1080i/50, 1080i/60 or 720p/60.



Display size selection diagram

When you want to	Set the display size	Input signal	Display screen	Remarks
Play a 4:3 image in a 16:9 screen.	4 : 3			Blanking occurs on both sides.
Play a 4:3 image in a 16:9 screen with the height and width of the middle of the screen enlarged on equal scales and with both sides appearing somewhat enlarged.	Panoramic	(4:3 signal)		
Play a 16:9 VISTA size image from a 4:3 image faithfully reproduced on the 16:9 screen.	Zoom	 (Vista)		<ul style="list-style-type: none"> • The 4:3 image is called a letterbox image. • In some cases, some slight blanking may remain at the top and bottom.
Play a 21:9 Cinema size image from a 4:3 image expanded vertically on the 16:9 screen.	Cinema	 (Cinema)		In some cases, some slight blanking may remain at the top and bottom.
Play a 4:3 image faithfully in a 16:9 screen in the standard vertical size and horizontally squeezed.*	Full	 (Squeeze)		* An image with an aspect ratio of 16:9 shrunk horizontally to 4:3 to display in a 4:3 screen

Vertical picture position can be adjusted for [Panoramic], [Zoom] and [Cinema] mode as follows.

1. Press the SIZE button and ▲ ▼ SELECT buttons during picture size display.

2. The position display will appear.

3. The adjustment range of each picture size is as shown below.

[Panoramic] - 12 to + 12

[Zoom] and [Cinema] - 31 to + 31

4. When 1080i/50 or 1080i/60 component signal is received, vertical position can be adjusted only one step up. (The range: 0 to +1)

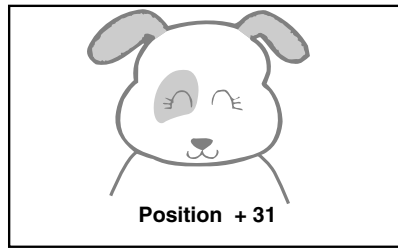

Press ▲

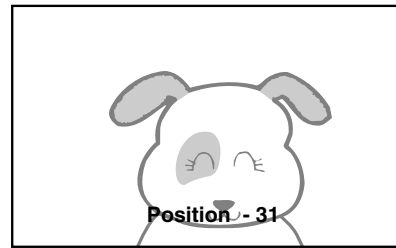

Press ▼

ATTENTION

Using a wide-screen monitor

- This monitor has a screen mode selection feature. If an incompatible screen mode is selected to play certain software, such as a TV program, the image will appear different from the original. Take this into consideration when making screen mode choices.
- Use of this monitor in its enlarged display mode with the wide feature enabled in coffee shops, hotels and other establishments for commercial or public viewing purposes could infringe on the copyright holder's rights protected by Copyright Law.
- When a normal 4:3 image is displayed over the entire screen in the Panoramic mode, parts of the periphery of the image may disappear and/or appear distorted in some cases. Use the 4:3 mode to view images which were created in 4:3 mode.
This mode allows 4:3 content to be viewed without picture distortion.

OPERATING INSTRUCTIONS (continued)

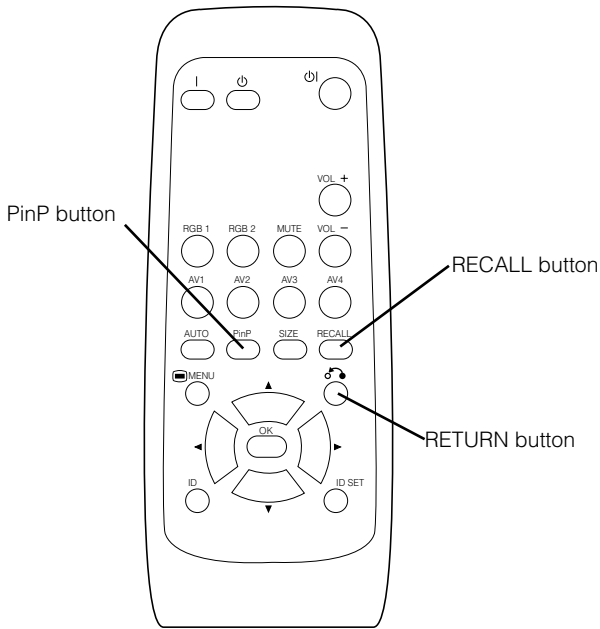
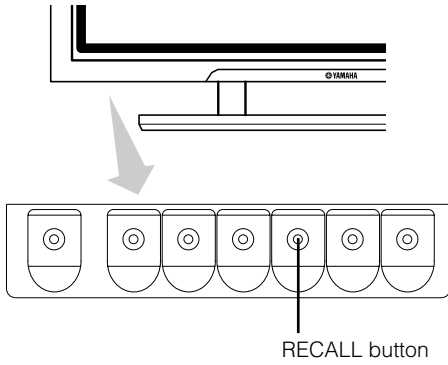

Displaying MULTI PICTURE

If the PinP button on the remote control is pressed MULTI PICTURE will display.

Activating the P-in-P mode from the RGB input screen

Pressing the PinP button once will display 2 pictures.

- This mode can be available from RGB1(DVI-PC) and RGB2(RGB) input.
- The speaker icon can be shifted left and right by pressing the ◀ and ▶ SELECT buttons; the audio of the video will be output from the side on which the speaker icon is located.
- The sub-screen position can be selected up and down by pressing ▼ ▲ SELECT buttons.
- When the speaker icon appears on the left of the subscreen, as in the illustration at right, you can use the AV1, AV2, AV3, or AV4 buttons to select the subscreen input mode.
- Pressing the PinP button or the RETURN button will cancel the 2 pictures display.
- "Frequency Mode" in the Setup Menu should be set to Movie when sub-screen is the component signal of 1080i/50 or 1080i/60.

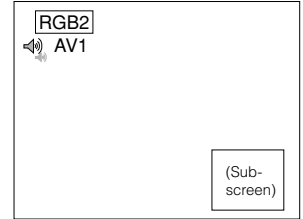

AV1: Displays the VIDEO input signal of the sub-screen.

Activating the Split mode from the video input screen

Pressing the PinP button one time will display 2 pictures.

- The speaker icon can be shifted left and right by pressing the ◀ and ▶ SELECT buttons; the audio of the video will be output from the side on which the speaker icon is located.
- The same video input mode cannot be selected for both screens at the same time.
- Pressing the PinP button or the RETURN button will cancel the 2 pictures display.
- When the Video input is set to RGB Video, this Split mode is not possible.
- Refer to the table for 2 pictures (Split) mode.

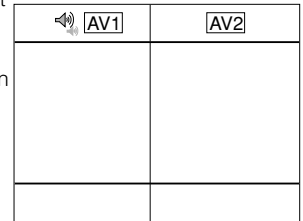

2 Pictures (Split)

Input terminal	AV1~AV4		AV1, AV2						RGB1	RGB2	
	Main	Sub	PAL-N	NTSC-M PAL-M	576i 576p	480i 480p	1080i/50	1080i/60	720p/60	STB	Component
AV1 ~AV4	PAL-N		○	○	○	○	○	○	○		
	NTSC-M, PAL-M		○	○	○	○	○	○	○		
AV1 AV2	576i, 576p		○	○							
	480i, 480p		○	○							
	1080i/50		○	○							
	1080i/60		○	○							
	720p/60		○	○							
RGB1	STB										
RGB2	Component		○	○	○	○	○	○			

(○ : Available)

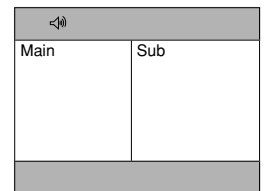

NOTE

- Even if the input of the horizontal / vertical synchronizing signal (or video signal) stops in the MULTI PICTURE display, the mode will not change to power save mode.
- Please be careful since image retention will occur if the plasma monitor is left in MULTI PICTURE display state for a long period of time.

Input Signal Screen Display

The input signal status can be displayed on the screen by pressing the RECALL button of the remote control or the monitor.

- The display will go out in approximately 6 seconds.

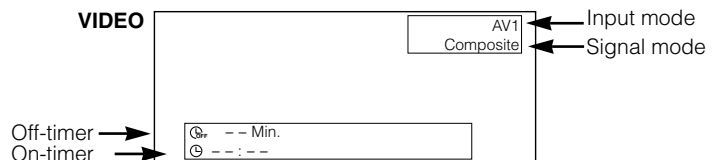

OPERATING INSTRUCTIONS (continued)

PICTURE MENU

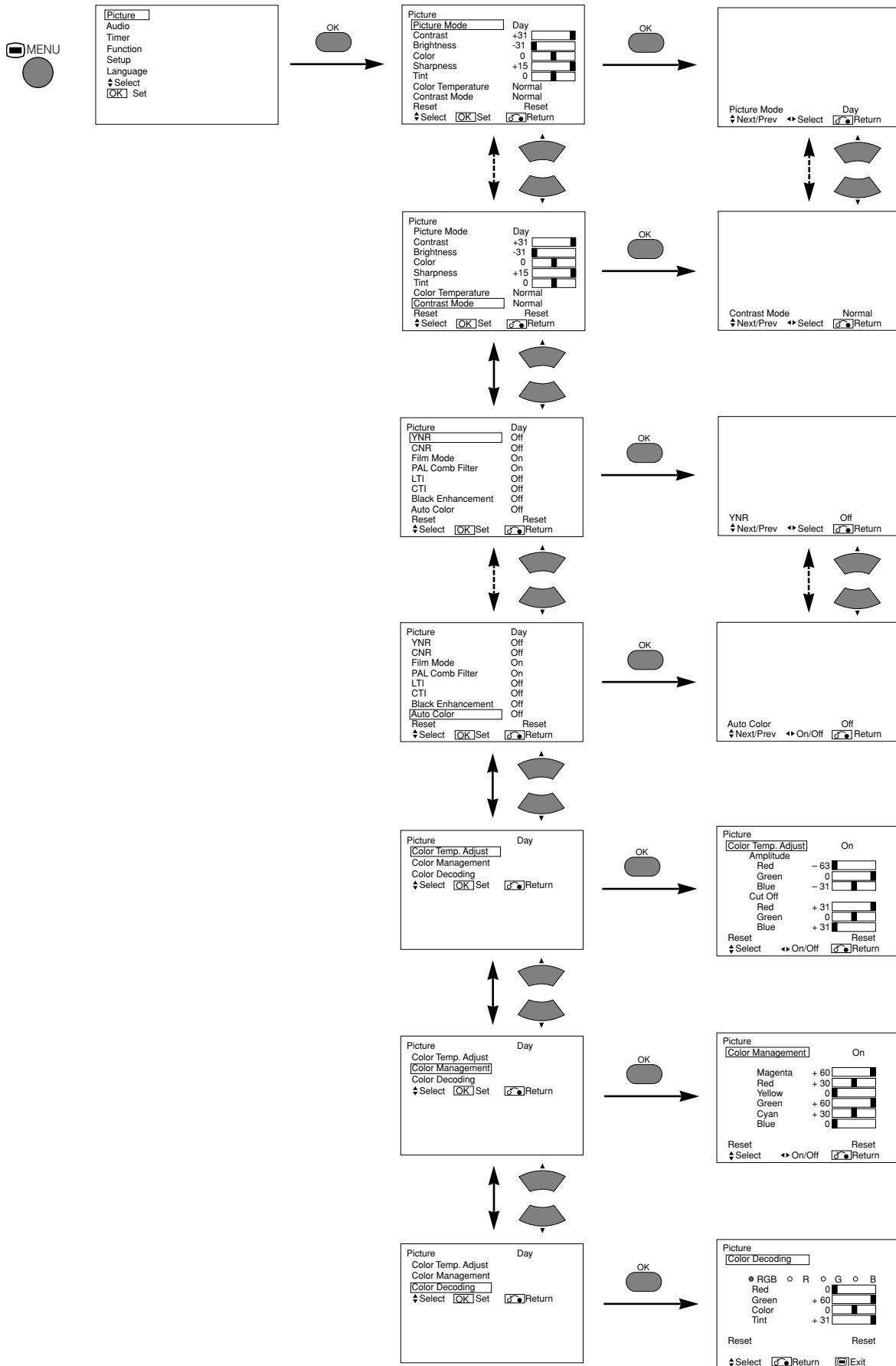

OPERATING INSTRUCTIONS (continued)

PICTURE MENU (continued)

Selected characters		◀	▶	Setup hint
Picture Mode				Day: This setting is best for very bright ambient lighting. Night: This setting is for normal lighting conditions.
Contrast		Narrows the gap between brightness and darkness.	Broadens the gap between brightness and darkness.	Adjust for maximum visibility to suit the ambient brightness. This can be adjusted further till [+40] by pressing and holding ▶ cursor button at [+31]. The color for [+32] to [+40] numbers will change from white to magenta. This special mode is better for dark scenes. For normal viewing we recommend that the Contrast is set to [+31]. "Panel Life" in the Function Menu should be set to Normal when this Contrast setting is adjusted.
Brightness		Black is subdued for increased overall darkness.	Black is set off for increased overall brightness.	Adjust to taste.
Color		Darkens colors.	Lightens colors.	Adjust to taste.
Sharpness		Soft	Sharp	Normally set to Centre position. Shift to the minus (-) side for a softer effect and plus (+) for a sharper picture.
Tint		Enhances red and weakens green.	Enhances green and weakens red.	This is adjustable when receiving PAL/SECAM signal. Then the character will be grayed out. Adjust for most realistic skin color.
Color Temperature				Normally set to Cool.
Contrast Mode				Dynamic: Emphasizes the differences between video shadings to improve the feeling of contrast. Normal: The gradation of an image is reproduced as faithfully as possible. Auto: Detects image brightness and automatically adjusts for natural brightness.
Reset			(Selects the Reset mode)	The original factory settings for the items of this Menu page can be restored by pressing the OK button.
YNR				Performs picture signal noise reduction. Turn up to reduce noise.
CNR				Performs color signal noise reduction. Turn up to reduce noise. It will be fixed as Off only when selecting DVI-STB mode.
Film Mode				On: Automatically detects the movie film material and faithfully reproduces the original film image. Off: Set to OFF when switching between images does not appear natural.
PAL Comb Filter				This is available only when receiving a PAL composite signal. Turn On to reduce the discolorations in fine picture detail and provide purer color.
LTI				Adjusts the sharpness of the picture signal.
CTI				Adjusts the sharpness of the color signal.
Black Enhancement				Adjusts the black level compensation.
Auto Color				This is available only when receiving an NTSC composite/S.Video signal. This monitors and adjusts the color to maintain constant color levels. It also maintains natural flesh tones while preserving fidelity of background colors.
Color Temp. Adjustment				Turn On when you wish to change color temperature depending on the user's preference.
Amplitude	Red	Brighter scenes are decreased in reddish color.	Brighter scenes are increased in reddish color.	Adjust color temperature depending on the user's preference. These settings are independently stored in each of the 4 Color Temperature modes.
	Green	Brighter scenes are decreased in greenish color.	Brighter scenes are increased in greenish color.	
	Blue	Brighter scenes are decreased in bluish color.	Brighter scenes are increased in bluish color.	
Cut Off	Red	Dark scenes are decreased in reddish color.	Dark scenes are increased in reddish color.	
	Green	Dark scenes are decreased in greenish color.	Dark scenes are increased in greenish color.	
	Blue	Dark scenes are decreased in bluish color.	Dark scenes are increased in bluish color.	

OPERATING INSTRUCTIONS (continued)

PICTURE MENU (continued)

Selected characters			Setup hint
Color Management			Turn On when the original balance of each color is required to adjust to suit user preferences.
Magenta	Magenta is weakened.	Magenta is strengthened.	This adjusts listed colors individually to make them either deeper or more pure. These settings are independently stored in each of the 4 Color Temperature modes.
Red	Red is weakened.	Red is strengthened.	
Yellow	Yellow is weakened.	Yellow is strengthened.	
Green	Green is weakened.	Green is strengthened.	
Cyan	Cyan is weakened.	Cyan is strengthened.	
Blue	Blue is weakened.	Blue is strengthened.	
Color Decoding			Select the single color screen you need to adjust R/G/B level individually depending on the user's preference. Set it back to RGB mode that indicates each color (R/G/B) mode after adjusting. Press the OK button every time the setting is changed.
Red	Darkens red only.	Lightens red only.	This adjusts R/G/B levels or tints to make the color appear natural. These settings are independently stored in each of the 4 Color Temperature modes.
Green	Darkens green only.	Lightens green only.	
Color	Darkens colors.	Lightens colors.	
Tint	Enhances red and weakens green.	Enhances green and weakens red.	

FUNCTION MENU

1 item is added to the Menu shown in the page [20](#).

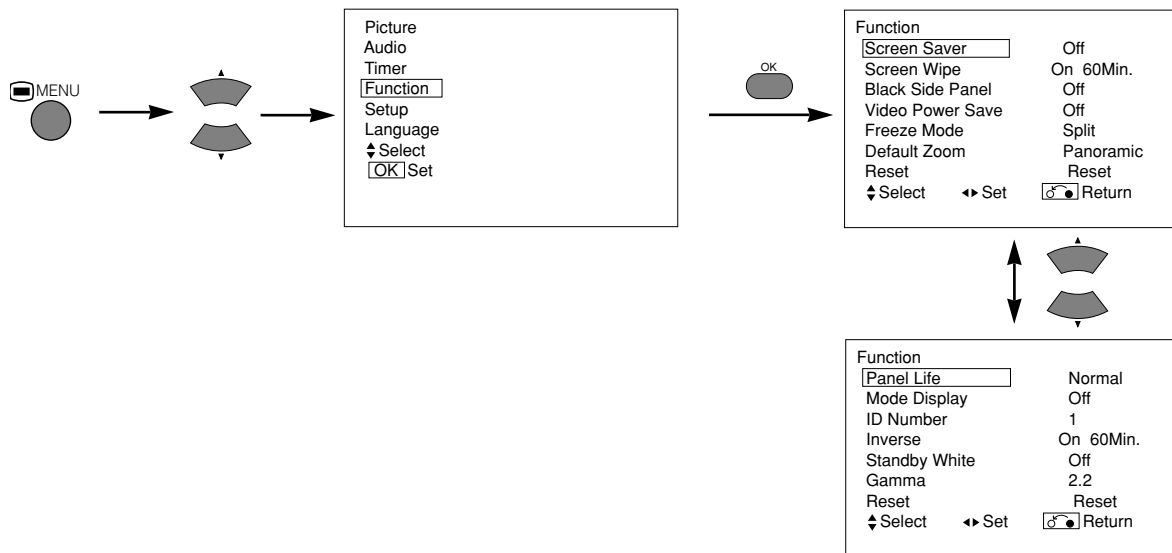

Selected characters			Setup hint
Video Power Save			This is used to reduce power consumption for video input when there is no video signal. Setting it to On will place the monitor to the standby mode when the AV input with no signal is selected.

OPERATING INSTRUCTIONS (continued)

SETUP MENU

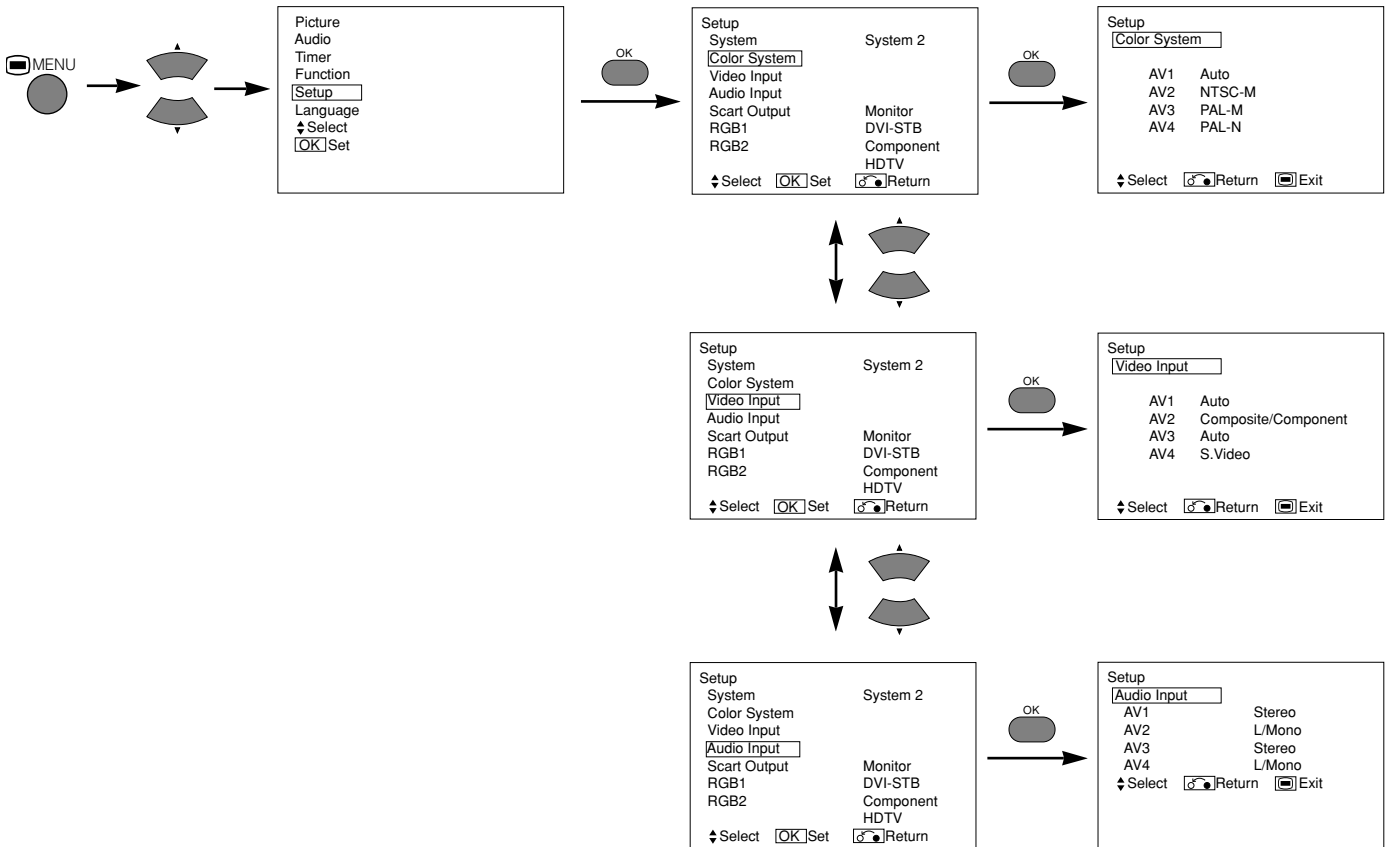

Selected characters	Navigation	Setup hint
System	System1 ↔ System2	Do not change the original setting. (System1 : Europe/Asia, System2 : North America)
Color System		
AV1	Auto ↔ NTSC-M PAL-N ↔ PAL-M	This should correspond to the color system of the signal from the equipment that is connected to the AV1 video input terminal. • Normally, set this to Auto. The system of the input signal will be automatically recognized. • If the input signal contains a lot of noise or has a low level at Auto and the operation is erratic, set this to match the input signal. • When the component signal is received, this setting is not available (grayed out).
AV2		(Same to AV1)
AV3		
AV4		
Video Input		
AV1	Auto ↔ HDTV ↔ SDTV/DVD	This should correspond to the signal mode of the signal from the equipment that is connected to AV1 video input terminal. • Normally, set this to Auto. The signal mode of the input signal will be automatically recognized. • If the input signal contains a lot of noise or has a low level at Auto and operation is erratic, set this to match the input signal.
AV2 (1st step)	RGB ↔ Composite/Component	This should correspond to the signal mode of the signal from the equipment that is connected to AV2 video input terminal.
AV2 (2nd step)	Auto ↔ HDTV ↔ SDTV/DVD	This step should be set only when [Composite/Component] is selected on the 1st step. The procedure is same as for AV1.
AV4	S.Video ↔ Composite	• If the signal from the equipment that is connected to the AV4 Scart input terminal is S.Video or Composite, set this to correspond to that signal. • If the signal is RGB, it will be automatically recognized and this setting will have no effect.

OPERATING INSTRUCTIONS (continued)

SETUP MENU (continued)

Selected characters	◀	▶	Setup hint
Audio Input			
AV1	→ Stereo ↔ L/Mono ←		This should correspond to the audio signal from the equipment that is connected to the AV1 audio input terminal. If the signal is monaural audio, set this to L/Mono.
AV2			(Same to AV1)
AV3			
AV4			
Scart Output			Not Available (grayed out)
RGB1	→ DVI-PC ↔ DVI-STB ←		This should correspond to the signal mode of the signal from the equipment that is connected to the RGB1 DVI terminal.
RGB2 (1st step)	→ RGB ↔ Component ←		This should correspond to the signal mode of the signal from the equipment that is connected to the RGB2 D-sub terminal.
RGB2 (2nd step)	→ Auto ↔ HDTV ↔ SDTV/DVD ←		<p>This step should be set only when [Component] is selected on the 1st step.</p> <p>This should correspond to the signal mode of the signal from the equipment that is connected to the RGB2 D-sub terminal.</p> <ul style="list-style-type: none"> • Normally, set this to Auto. The signal mode of the input signal will be automatically recognized. • If the input signal contains a lot of noise or has a low level at Auto and the operation is found erratic, set this to match the input signal.

OTHER FEATURES

Automatic Store

Approximately 1 sec. after adjustment is completed, the adjustments will be recorded as shown in the table below.

Menu	Display	Registration condition
Picture	Picture Mode	1 setting is registered.
	Contrast	For every input function and every Picture Mode, 1 setting is registered.
	Brightness	
	Color	
	Sharpness	
	Tint	
	Color Temperature	
	Contrast Mode	
	YNR	
	CNR	
	Film Mode	
	PAL Comb Filter	
	LTI	
	CTI	
	Black Enhancement	
	Auto Color	
	Color Temp. Adjust	For every Color Temperature, 1 setting is registered.
	R Amplitude	
	G Amplitude	
	B Amplitude	
	R Cut Off	
	G Cut Off	
	B Cut Off	
Color Management	For every input function and every Picture Mode, 1 setting is registered.	
Magenta	1 setting is registered.	
Red		

Menu	Display	Registration condition
Picture	Yellow	1 setting is registered.
	Green	
	Cyan	
	Blue	
	Color Decoding	-
	Red	For every Color Temperature, 1 setting is registered.
	Green	
	Color	For every input function and every Picture Mode, 1 setting is registered.
	Tint	
	Function	Video Power Save
Setup	System	1 setting is registered.
	Color System	1 setting is registered.
	AV1	
	AV2	
	AV3	
	AV4	
	Video Input	-
	AV1	1 setting is registered.
	AV2	
	AV4	
	AV4	
	Audio Input	-
	AV1	1 setting is registered.
	AV2	
AV3		
AV4		
RGB1		
RGB2		

• The previously recorded items will be lost.

TROUBLESHOOTING

Symptoms That Seemingly Appear to be Failures

Make the checks suggested below depending on the symptoms observed. If the symptoms remain uncorrected, contact your dealer.



CAUTION

Customer servicing can be hazardous.

Symptom	Point to check	See page
<ul style="list-style-type: none"> The screen becomes dark and the images cannot be seen during VCR special playback (fast forward, rewind). 	<ul style="list-style-type: none"> This sometimes occurs when a component output VCR such as the 480i is connected. This is not a malfunction; therefore, please take note that this may occur. When it does occur, change to composite output, or S.video output. 	—

PRODUCT SPECIFICATIONS

This table shows the specifications when the optional video unit has been inserted.

Panel	Display dimensions	Approx. 42 inches (922 (H) x 522 (V) mm, diagonal 1059mm)
	Resolution	1024 (H) x 1024 (V) pixels
Net dimensions (excluding pedestal)		1030 (W) x 636 (H) x 91 (D) mm
Net weight (excluding pedestal)		34.9kg
Ambient conditions	Temperature	Operating : 5°C to 35°C, Storage : 0°C to 40°C
	Relative humidity	Operating : 20% to 80%, Storage : 20% to 90% (non-condensing)
Power supply		AC100 - 240V, 50/60Hz
Power consumption/at standby		365W / <3W
Audio output		12W + 12W (6Ω)
(RGB input)		
Input signals	Input terminals	RGB1 DVI input terminal (DVI-D) RGB1 audio input terminal (3.5mm Stereo Mini Jack) RGB2 analog RGB input terminal (D-sub 15-pin) RGB2 audio input terminal (3.5mm Stereo Mini Jack)
	Video signals	0.7 V/1.0 Vp-p, analog RGB (Recommended Signal) 480i, 576i, 480p, 576p, 1080i/50, 1080i/60, 720p/60
	Sync signals	H/V separate, TTL level [2KΩ] H/V composite, TTL level [2KΩ] Sync on green, 0.3 Vp-p [75Ω]
Recommended signal		46 modes  
(Video input)		
Input signals	Input terminals	AV1: composite video input terminal (RCA) AV1: Y PB PR video input terminal (RCA) AV1: L/R audio input terminal (RCA) AV2: composite video input terminal (RCA) AV2: Y/G PB/B PR/R video input terminal (RCA) AV2: L/R audio input terminal (RCA) AV3: composite video input terminal (RCA) AV3: S video input terminal (RCA) AV3: L/R audio input terminal (RCA) AV4: composite video / S video / RGB / L/R audio input terminal (Scart)
	Video signals	AV1: NTSC-M, PAL-M, PAL-N AV1: 480i, 576i, 480p, 576p, 1080i/50, 1080i/60, 720p/60 AV2: NTSC-M, PAL-M, PAL-N AV2: 480i, 576i, 480p, 576p, 1080i/50, 1080i/60, 720p/60, RGB AV3: NTSC-M, PAL-M, PAL-N AV4: NTSC-M, PAL-M, PAL-N AV4: RGB
Video output Signal		OUTPUT (MONITOR): composite video monitor-output terminal (RCA) OUTPUT (MONITOR): L/R audio monitor- output terminal (RCA) AV4: composite video / L/R audio monitor-output terminal (SCART)
Recommended signal		13 modes 

• The monitor takes at least 30 minutes to attain optimal picture quality.

PRODUCT SPECIFICATIONS (continued)

Signal Input

RGB terminal (D-sub 15-pin connector)

Pin	Input signal
1	R (Pr/Cr)
2	G or sync on green (Y)
3	B (Pb/Cb)
4	No connection
5	No connection
6	R.GND (Pr/Cr, GND)
7	G.GND (Y, GND)
8	B.GND (Pb/Cb, GND)
9	No connection
10	GND
11	No connection
12	[SDA]
13	H. sync or H/V composite sync
14	V.sync. [V.CLK]
15	[SCL]

() : With component input

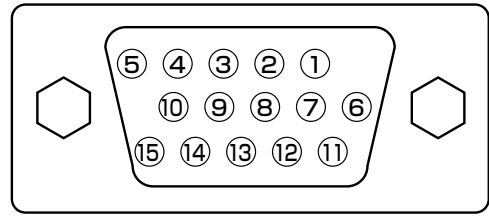

- When different kinds of input signals are simultaneously input to the monitor via a graphics board or the like, the monitor will automatically select the signals in the following priority order:

Sync signal type	Priority
H/V separate sync.	1
H/V composite sync.	2
sync.on Green *	3

*There may be instances when correct display is not possible even when displaying the signals listed on the following page. In this case, use H/V separate sync, H/V composite sync.

S-input connector pin specifications

Pin	Input signal
1	Y
2	Y-GND
3	C
4	C-GND
Frame	GND

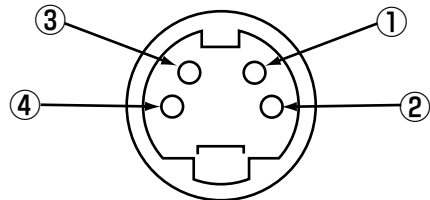

Scart connector pin specifications

Pin	Signal	Pin	Signal
1	AUDIO OUT (RIGHT)	12	Not Used
2	AUDIO IN (RIGHT)	13	RGB-R GND
3	AUDIO OUT (LEFT/MONO)	14	GND
4	AUDIO GND	15	RGB-R / S.VHS CHROMINANCE IN
5	RGB-B GND	16	BLANKING SIGNAL
6	AUDIO IN (LEFT/MONO)	17	COMPOSITE VIDEO GND
7	RGB-B IN	18	BLANKING SIGNAL GND
8	AUDIO/RGB SWITCH / 16:9	19	COMPOSITE VIDEO OUT
9	RGB-G GND	20	COMPOSITE VIDEO / S.VHS LUMINANCE IN
10	Not Used	21	GND / SHIELD (CHASSIS)
11	RGB-G IN		

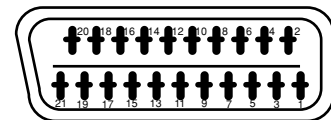

PRODUCT SPECIFICATIONS (continued)

Recommended Signal List

With Digital RGB signal input (RGB1 input)

No.	Signal mode			Horizontal frequency (kHz)	Dot clock frequency (MHz)	Setup Menu Condition		Remarks
	Signal Name	Resolution	Vertical frequency (Hz)			DVI-PC	DVI-STB	
1	VGA	640 X 400	70.08	31.47	25.18	○		
2		640 X 480	59.94	31.47	25.18	○	○	
3	W-VGA	864 X 480	59.94	31.47	34.24	○		WVGA type : On
4	VESA	640 X 480	72.81	37.86	31.50	○		
5		640 X 480	75.00	37.50	31.50	○		
6		640 X 480	85.01	43.27	36.00	○		
7		800 X 600	56.25	35.16	36.00	○		
8		800 X 600	60.32	37.88	40.00	○		
9		800 X 600	72.19	48.08	50.00	○		
10		800 X 600	75.00	46.88	49.50	○		
11		800 X 600	85.06	53.67	56.25	○		
12		1024 X 768	60.00	48.36	65.00	○		
13		1024 X 768	70.07	56.48	75.00	○		
14	1024 X 768	75.03	60.02	78.75	○			
15	480p	720 X 480	59.94	31.47	27.00		○	EIA-861
16	720p/60	1280 X 720	60.00	45.00	74.25		○	EIA-861
17	1080i/60	1920 X 1080	60.00	33.75	74.25		○	EIA-861

(○ : acceptable)

With Composite Input(AV1~AV4 input) and S-video Input (AV3 input).

No.	Signal mode			Horizontal frequency (kHz)	Dot clock frequency (MHz)	Remarks
	Signal Name	Resolution	Vertical frequency (Hz)			
1	NTSC-M PAL-M	525	59.94	15.73	—	
2	PAL-N	625	50.00	15.63	—	

With R, G, B Video input (AV2 and AV4 input).

No.	Signal mode			Horizontal frequency (kHz)	Dot clock frequency (MHz)	Remarks
	Signal Name	Resolution	Vertical frequency (Hz)			
1	(NTSC-M,PAL-M)	525	59.94	15.73	—	
	(PAL-N)	625	50.00	15.63		

With component input (AV1, AV2 and RGB2-component input).

No.	Signal mode			Horizontal frequency (kHz)	Dot clock frequency (MHz)	Remarks
	Signal Name	Resolution	Vertical frequency (Hz)			
1	576i	576	50.00	15.63	—	
2	480i	480	59.94	15.73	—	
3	576p	576	50.00	31.26	—	
4	480p	480	59.94	31.47	—	
5	1080i/50	1080	50.00	28.13	—	
6	1080i/60	1080	60.00	33.75	—	
7	720p/60	720	60.00	45.00	—	

- The monitor differentiates the signal modes according to the horizontal and vertical frequencies and the horizontal and vertical sync signal polarities. Note that different signals having all these elements alike may be handled as the same signal.
- Displaying images with more than 512 lines of vertical resolution at Full display (compressed display) can result in the interpolation of stripes.



©2003 YAMAHA CORPORATION All rights reserved.

YAMAHA ELECTRONICS CORPORATION, USA 6660 ORANGETHORPE AVE., BUENA PARK, CALIF. 90620, U.S.A.
YAMAHA CANADA MUSIC LTD. 135 MILNER AVE., SCARBOROUGH, ONTARIO M1S 3R1, CANADA
YAMAHA ELECTRONIK EUROPA G.m.b.H. SIEMENSSTR. 22-34, 25462 RELLINGEN BEI HAMBURG, F.R. OF GERMANY
YAMAHA ELECTRONIQUE FRANCE S.A. RUE AMBROISE CROIZAT BP70 CROISSY-BEAUBOURG 77312 MARNE-LA-VALLEE CEDEX02, FRANCE
YAMAHA ELECTRONICS (UK) LTD. YAMAHA HOUSE, 200 RICKMANSWORTH ROAD WATFORD, HERTS WD18 7GQ, ENGLAND
YAMAHA SCANDINAVIA A.B. J A WETTERGRENS GATA 1, BOX 30053, 400 43 VÄSTRA FRÖLUNDA, SWEDEN
YAMAHA MUSIC AUSTRALIA PTY, LTD. 17-33 MARKET ST., SOUTH MELBOURNE, 3205 VIC., AUSTRALIA

YAMAHA CORPORATION
Printed in Japan  QR60121



High Definition Plasma monitor

PDM-4210

Connection Guide

Basic connection to an AV Receiver

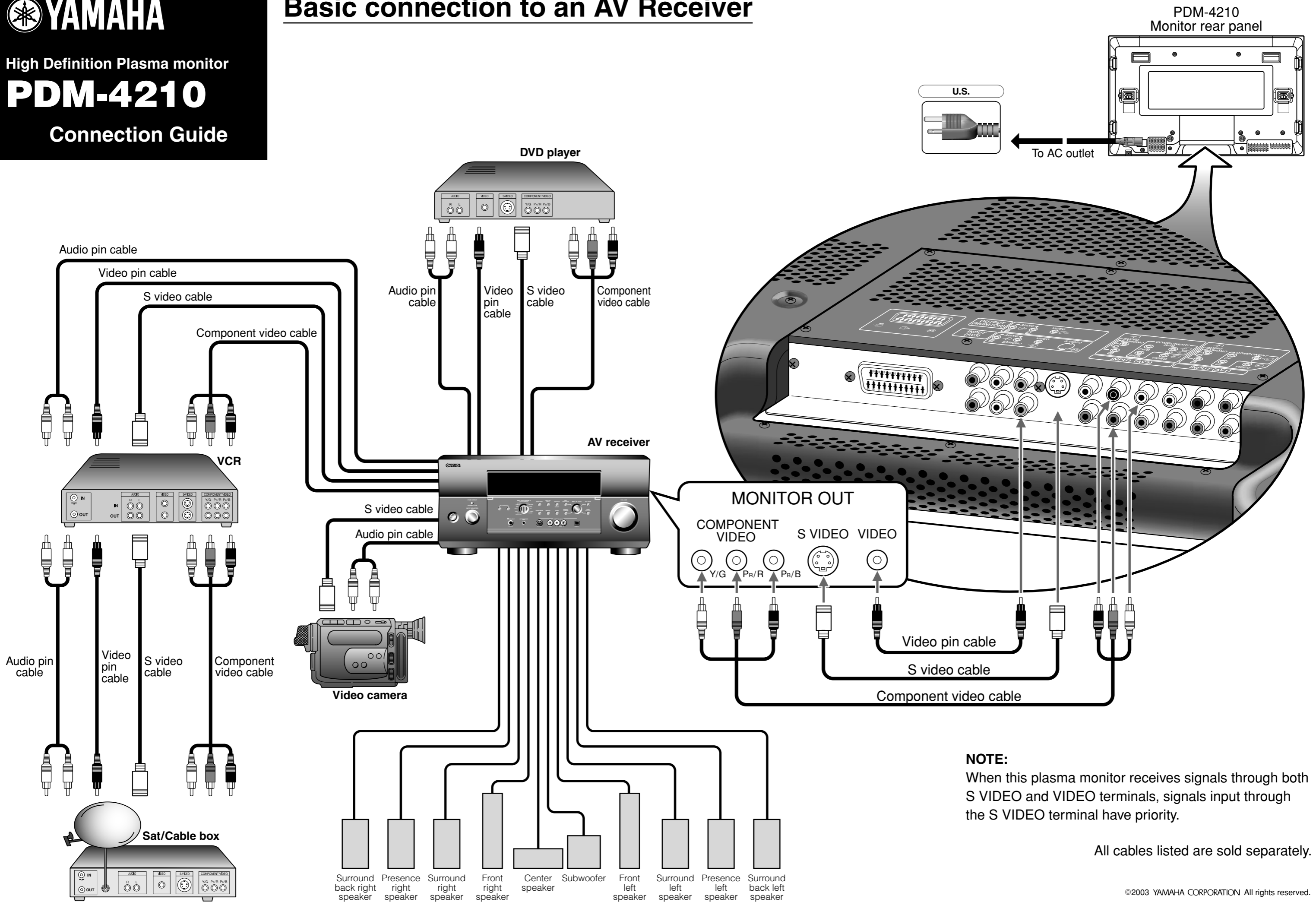

Examples of Image Retention
Exemples de Rétention d'Image
Beispiele für Bildspeichereffekte
Exempel på kvarstående bilder
Ejemplos de Retención de Imagen

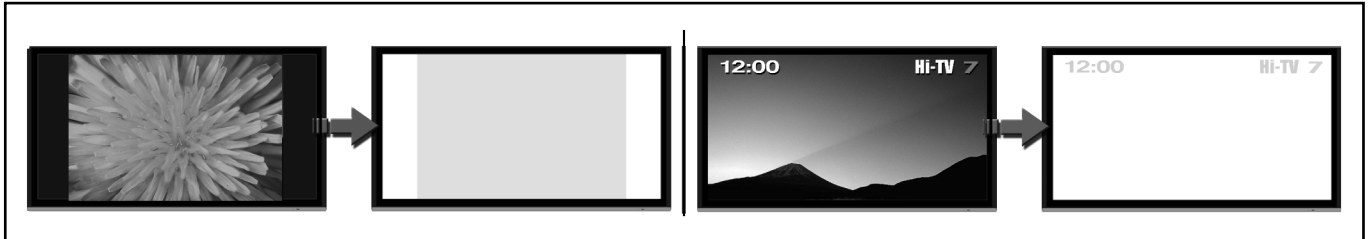

English

Image Retention

Image Retention can be an issue for all plasma monitors, however if you follow the simple guidelines listed below, you can enjoy many years of viewing.

YAMAHA has included a number of features in our range of plasma monitors which help to reduce image retention. Please refer to the user manual for this model for instruction on how to use these features.

- * Ensure screen save mode is activated.
- * Always display the image in a mode that fills the screen.
- * Avoid using split screen modes for long periods of time.
- * Do not allow the "On Screen Display" to stay on for long periods of time.
- * Do not display still images, such as menus from game consoles, Teletext, PCs or logos on the monitor for long periods of time.
- * We recommend that you reduce "Contrast" and "Brightness" levels as much as possible.

Français

Rétention d'image

La rétention peut être un problème pour les écrans Plasma, néanmoins si vous suivez les simples instructions suivantes, vous pourrez profiter de votre écrans pendant de longues années.

YAMAHA a pourvu ses écrans moniteurs plasma de fonctions permettant de réduire la rétention d'image. Veuillez s'il vous plaît vérifier dans le mode d'emploi de ce modèle comment utiliser ces fonctions.

- * Assurez vous que l'économiseur d'écran est bien activé.
- * Vérifiez toujours que le format d'image que vous utilisez est constamment adapté à l'écran.
- * Evitez d'utiliser le mode de séparation d'écran sur une longue période.
- * Ne pas laisser le menu à l'écran affiché pendant de longues périodes.
- * Ne pas afficher des images fixes, comme les menus des jeux vidéo, télétexte, ordinateurs ou Logos sur l'écran pendant de longues périodes.
- * Nous vous recommandons également de régler le contraste et la luminosité à un niveau le plus faible possible.



NOTE

The video unit (PTB-4210) is included as standard equipment with this model ; therefore, descriptions of “Optional Video Unit Function” in this text can be used as is.

REMARQUES

L'appareil vidéo (PTB-4210) est fourni en standard avec ce modèle ; les explications des opérations relatives à la fonction de la vidéo dans ce texte peuvent donc être utilisées telles quelles.

PDS-242

Pedestal

Thank you for purchasing the Pedestal.

To ensure correct usage, please read this instruction manual thoroughly. After reading, please store this manual in a safe place for future reference.

This pedestal is for use only with the following models:

PDM-4210, PDM-4210E

- Request an installation specialist to install this unit.
- YAMAHA assumes absolutely no responsibility for injuries and damages that may occur due to improper installation and handling.

Parts Configuration Chart

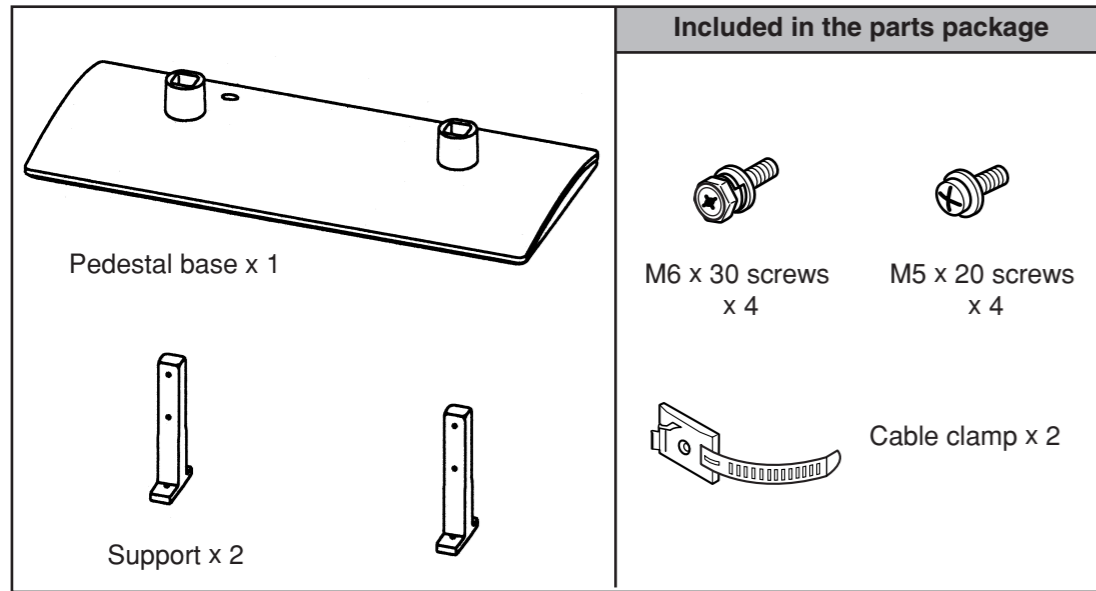

Product Specifications

External Dimensions	700 (W) x 184 (H) x 300 (D) mm (27-9/16 (W) x 7-1/4 (H) x 35-7/16 (D) inches)
Weight	4.2kg (9 lbs. 4 oz.)
Main material /Surface treatment	Pedestal base, Support : Aluminum alloy / Baked paint finish

Usage cautions

- Do not allow an adhesive material, such as an adhesive tape, into contact with the surface of the pedestal, as they may cause the exterior surface to peel.
- Wipe off dirt using a dry cloth. To remove ingrained dirt, use a cloth saturated with a diluted neutral detergent solution and squeezed until damp. Use of organic solvents, such as benzene, thinner, and household wax, for cleaning could result in a degenerated or discolored material. (When using a chemical duster, observe the relevant instructions.)

Assembly Method

Prepare a phillips screwdriver before proceeding with assembly.

Assembling the pedestal

1. Insert the support into the pedestal base and secure it in position by tightening four M5 x 20 screws from the bottom.

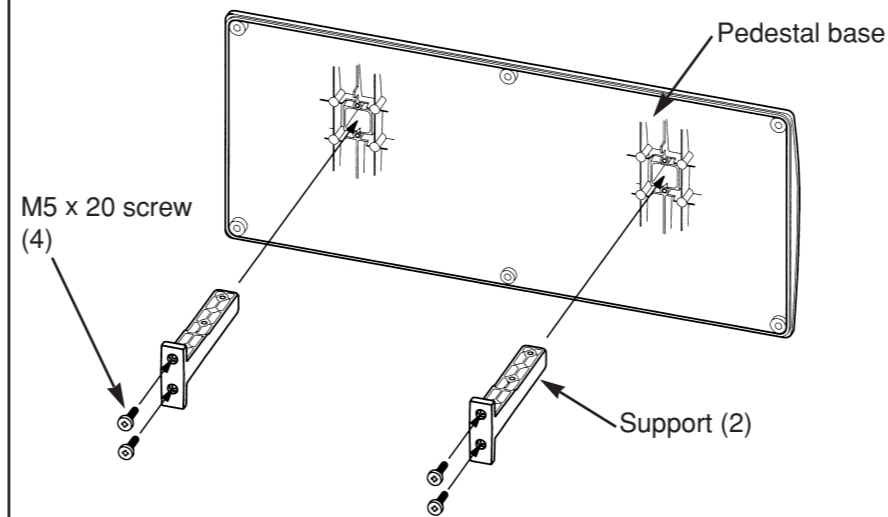

Attaching the Plasma Monitor to the pedestal

2. Insert the pedestal support into the square holes on the bottom of the plasma monitor.

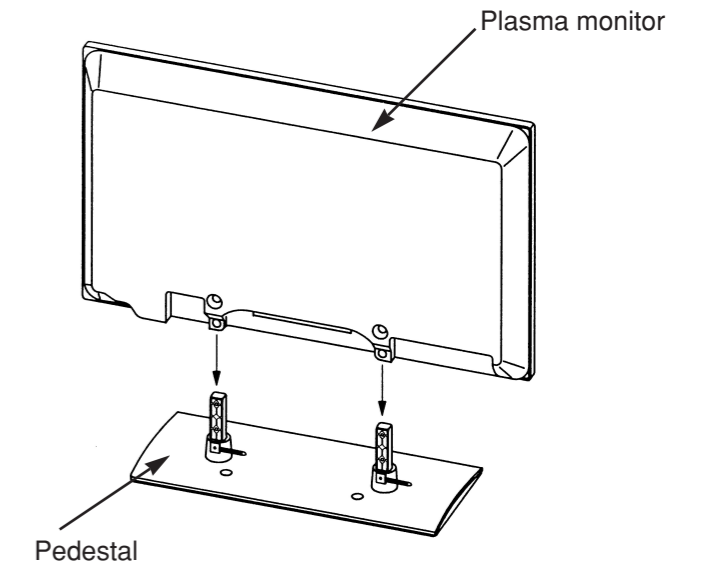

3. Fix the pedestal to the plasma monitor using four M6 x 30 screws.

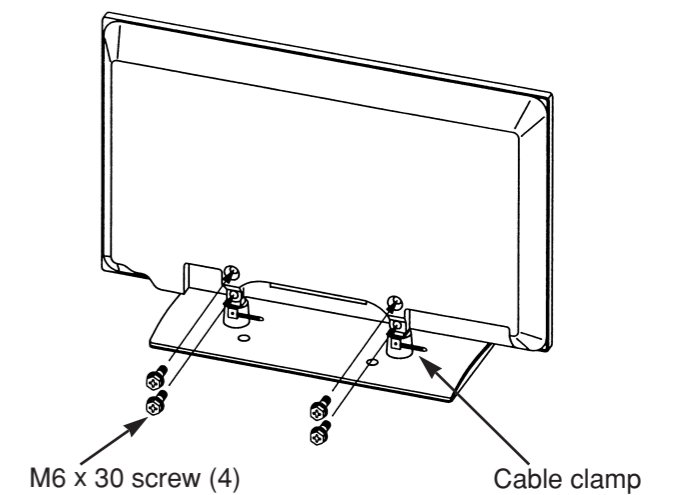

4. Connect the cables to the plasma monitor, attach the cable clamps to the pedestal where necessary, and fasten the cables to the clamps.

Dimension diagram

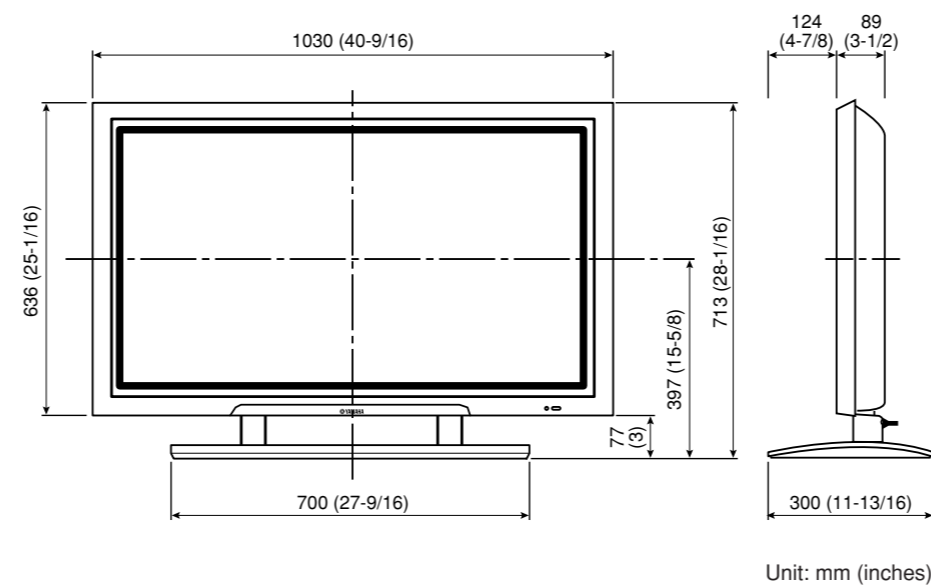

To ensure correct usage

WARNING

- **Always use at least two people to perform installation work.**
Injury could result from dropping heavy objects.
- **Use the specified bolts and screws in the specified places and tighten firmly.**
Failure to do this could cause injury if the plasma monitor falls.

CAUTION

Securing to a wall or post

Using the hooks at center of the rear of the plasma monitor, a commercially available cord or chain, and a clamp, secure the set to a firm wall or to a wall post.

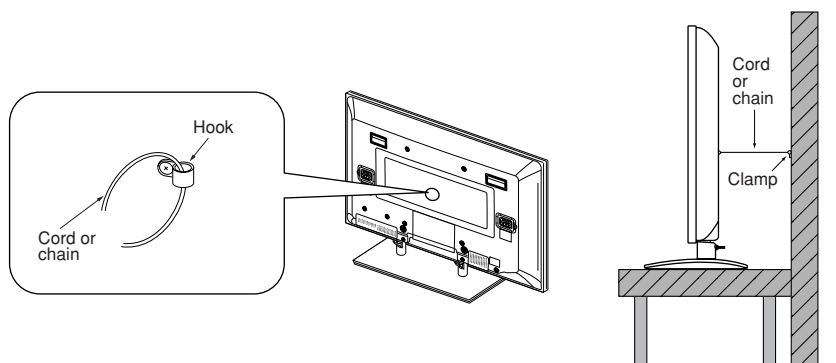

Securing to a tabletop

Using commercially available wood screws (two), fasten the set to the clamping screw holes on the rear of the pedestal as shown.

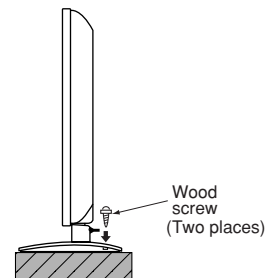

- **Do not mount the plasma monitor in an unstable location.**
The monitor could fall or break, resulting in physical injury.
- **Do not block the ventilation holes. Ensure that there is sufficient clearance for ventilation.**
The internal temperature of the plasma monitor could elevate possibly resulting in fire.
- **Avoid installing in locations where the temperature and humidity are excessively high, and where contact with water is possible.**
These can result in fire or electrical shock.
- **Do not alter any parts or use broken parts.**
This could result in the plasma monitor falling causing injury.



©2003 YAMAHA CORPORATION All rights reserved.

YAMAHA ELECTRONICS CORPORATION, USA 6660 ORANGETHORPE AVE., BUENA PARK, CALIF. 90620, U.S.A.
YAMAHA CANADA MUSIC LTD. 135 MILNER AVE., SCARBOROUGH, ONTARIO M1S 3R1, CANADA
YAMAHA ELECTRONIK EUROPA G.m.b.H. SIEMENSSTR. 22-34, 25462 RELLINGEN BEI HAMBURG, F.R. OF GERMANY
YAMAHA ELECTRONIQUE FRANCE S.A. RUE AMBROISE CROIZAT BP70 CROISSY-BEAUBOURG 77312 MARNE-LA-VALLÉE CEDEX02, FRANCE
YAMAHA ELECTRONICS (UK) LTD. YAMAHA HOUSE, 200 RICKMANSWORTH ROAD WATFORD, HERTS WD18 7GQ, ENGLAND
YAMAHA SCANDINAVIA A.B. J A WETTERGRENS GATA 1, BOX 30053, 400 43 VÄSTRA FRÖLUNDA, SWEDEN
YAMAHA MUSIC AUSTRALIA PTY, LTD. 17-33 MARKET ST., SOUTH MELBOURNE, 3205 VIC., AUSTRALIA

YAMAHA CORPORATION

Printed in Japan © 3023575